



KollektorElite^{XG} 16-Channel Digital Video Recording Systems

- **Powered by ViconNet software Version 3**
- **Next Generation “XG” look fits into today’s style**
- **Graphical Map feature supports realistic camera location (a workstation equipped with dual output VGA card will allow showing the Map on a dedicated monitor while viewing video on the other)**
- **Models available with up to 1.6 TB internal HD space**
- **Maximum recording rate of 480 fps automatically optimized for maximum recording rate per channel**
- **Hybrid proprietary compression based on MPEG4**
- **Museum Search (Smart Search) feature scans hours of video in minutes**
- **Video Motion Detection uses “Region of Interest” feature to enable alarms triggered by motion**
- **16 alarm inputs (NO or NC) and 8 relay alarm outputs (dry contact)**
- **Includes 16x4 analog video matrix on the rear panel controlled by the software locally and over the network**
- **Archive segments of video to a CD-R/CD-RW/DVD with viewer for playback on a standard PC**
- **Maximum resolution of 480 TV lines @ 720 x 488 (576 TVL @ 864 x 586 PAL) pixel capture without loss of video quality**
- **Simultaneous record, playback and transmission of up to 16 digital video and audio channels**
- **Macros are used for programming recording, alarm and display events**
- **Remote setup from any Kollektor Elite or workstation**
- **16 individual RS-422 ports for PTZ/Dome Control - no need for a distribution unit**
- **Built-in GUI provides quick setup of live view and playback video without affecting recording**
- **120 fps models available with internal hot swappable data base drives (RAID 5)**

Kollektor Elite XG is a 16-channel digital video recorder powered by ViconNet software platform. This platform allows each Kollektor Elite recorder to record video and audio from local analog inputs as well as video and audio streamed over the network from other recorders and IP cameras, providing outstanding flexibility.

ViconNet also powers each Kollektor Elite recorder with the ability to perform remote system configuration of other recorders on the network. Changes to camera tilting, macro programming and scheduling, as well as frame rate manipulation, are all possible from one or more recorders on the system; no separate workstation required.

ViconNet software is the application that runs Kollektor Elite recorders and ViconNet Workstations (see specification V113). The software capabilities outlined in specification V113 apply to Kollektor Elite Recorders as well as the ViconNet software package and workstation. ViconNet includes a nucleus where vital information of all system recorders and workstations is kept.

A Nucleus is one of the workstations (NVRs) or Kollektor units in a system that enables each system device to share video and configuration commands. The Nucleus can be configured on a specified Kollektor recorder or ViconNet Workstation. Backup versions of the Nucleus can also be configured on selected recorders or workstations.

Kollektor Elite utilizes two different video compression methods, selectable based on the application’s requirements.

- **NORMAL:** Optimized MPEG4; a proprietary compression algorithm developed by Vicon that produces outstanding video quality and extended recording durations.
- **FULL:** JPEG; standard full frame compression for use in situations that cannot use a motion compensation compression.

Kollektor Elite uses an MD5 type video authentication algorithm. MD5 is a standard authentication that is based on a 128-bit message used to verify data integrity.

Kollektor Elite offers internal hard drive storage up to 1.6 TB. An optional RAID storage unit can be connected for extended recording capability. Models are available that include an internal 5-bay HDD enclosure; one bay is used for the OS and is not part of the RAID array. The 4 data base drives are hot-swappable. These units do not have an integral CD drive. Refer to Table 3 for recording days data.

Kollektor Elite distributes its own collected video to each client, or other workstation, upon request over a network. Each workstation is capable of viewing 16 simultaneous cameras while supporting archiving, system configuration and the control of pan/tilt/zoom drives. 16 audio inputs are available for microphone connection.

Kollektor Elite includes full 16-channel simultaneous record and playback, integrated GUI for system configuration, playback and record on a SVGA monitor and support for NTSC/EIA and PAL/CCIR video cameras. In addition,

Product Specification

Kollektor Elite supports WAN/Internet connectivity for remote video and audio transmission.

The Kollektor Elite GUI offers complete configuration and control of the networked video. The Main Window provides a multi-channel display area containing up to 16 connected cameras and microphones. An optional map can be added with actual camera locations, making camera selection simple. The Main Window contains the necessary controls to operate and setup the system. The login window requires a preconfigured User Name and Password for access.

The site/device tree allows a user to view and activate connected sites containing cameras, PTZ cameras and microphones. The display controls allow a user to set the image quality.

The Navigator Window allows many of the same features of the Main Window for system playback functions.

The software platform offers features unequalled by other recorders. These features include:

Playback Utility with Multi-Screen Display Selection, AVI Creation, Museum Search, and Archiving

The Playback utility features a multi-screen display where cameras can be dragged-and-dropped for display.

The Museum Search button can be selected for a single camera where an accelerated search of the video within a user selected ROI (Region of Interest). The ROI uses a custom block-grid tool with a full set of pencil and erase tools. The number, and detection threshold, of the blocks will trigger a "minimum detection" area where the video is earmarked with a time/date stamp. These "episodes" can be viewed, selected and played back and saved as needed.

The Archiving Utility allows the saving of this selected video to the storage location of your choice. The video can be saved to any local or remote storage location, including CD-RW drives, recognized by the system.

Quick Playback/Camera Playback

The Quick Playback feature allows instantaneous playback of any currently recording, live-view window of a local camera.

When that screen is selected, there are 2 options; display of the camera information or selection of 7 playback intervals from 10 seconds to 30 minutes. When selected, the playback video is displayed in an adjacent window and the recording for all cameras is unaffected.

The user can also choose "Playback from..." and specify the exact date, time and database to play the camera from. In both options, the live view remains viewable.

Kollektor Elite is housed in an industrial-hardened case with all connections made from the back panel. It has a universal power supply that can accept 110 - 240 VAC.

Vicon requires the use of uninterruptible power supply systems (UPS) to prevent voltage fluctuations that can affect operation, cause video loss and cause damage to the equipment. Failure to comply voids the warranty.

ASSOCIATED EQUIPMENT AND ACCESSORIES

Kollektor Pro Digital Video Recorder, Product Code varies by model: 16-channel local-video networked digital video recorder for use with Kollektor Elite series recorders and ViconNet VN100V3/NVR5000 Workstations. Product Specification V128.

ViconNet VN1000V3 Master Workstation Software, Product Code 8797: Software CD for a PC for use with Kollektor Elite and Pro series recorders; registration required for use. Product Specification V113.

ViconNet VN-NVR Master Workstation, Product Code varies by model: PC preloaded with VN1000V3 Master Control Software for use with Kollektor Elite and Pro series recorders; registration required for use. Product Specification V113.

Model VN-MON Monitor, Product Code 8222: 17-inch VGA monitor for use with Kollektor Elite and Pro series recorders and ViconNet NVR5000 systems.

Model VN-17FLT Monitor, Product Code 8237: 17-inch flat-screen monitor for use with Kollektor Elite and Pro series recorders and ViconNet VN-NVR systems. Product Specification V127.

Model NETSWITCH-8 Network Switch, Product Code 7787: 8 port, 10/100 autosensing network switch, stackable.

NETSWITCH-16 Network Switch, Product Code 8495: 16-port, 10/100 autosensing network switch, stackable. Product Specification V161.

NETSWITCH-24 Network Switch, Product Code 8495-10: 16-port, 10/100 autosensing network switch, stackable. Product Specification V162.

Uninterruptible Power Supplies: 725, VA unit with DB9 (RS-232) and USB ports; 120 VAC input/output. Product Specification V147.

Model VN-RAIDA ViconNet/Kollektor RAID Storage Systems: Various RAID size storage systems for use with Kollektor Elite and Pro series recorders. Product Specification V133-10.

Product Specification

KEX120M-500	8993-01	KOLLECTOR ELITE XG SERVER; preloaded ViconNet Ver 3;16-channel networked digital video recorder, 120 fps, internal OS HD, 500 GB data HD and CD-RW drive, 16x4 analog video matrix, NTSC/EIA and PAL/CCIR
KEX120M-900	8949-01	KOLLECTOR ELITE XG SERVER; preloaded ViconNet Ver 3;16-channel networked digital video recorder, 120 fps, internal OS HD, 900 GB data HD and CD-RW drive, 16x4 analog video matrix, NTSC/EIA and PAL/CCIR
KEX120M-1200	8950-01	KOLLECTOR ELITE XG SERVER; preloaded ViconNet Ver 3; 16-channel networked digital video recorder, 120 fps, internal OS HD, 1.2 TB data HD and CD-RW drive, 16x4 analog video matrix, NTSC/EIA and PAL/CCIR
KEX120M-1600	8996-01	KOLLECTOR ELITE XG SERVER; preloaded ViconNet Ver 3; 16-channel networked digital video recorder, 120 fps, internal OS HD, 1.6 TB data HD and CD-RW drive, 16x4 analog video matrix, NTSC/EIA and PAL/CCIR
KEX120M-500R5	8993-20	KOLLECTOR ELITE XG SERVER; preloaded ViconNet Ver 3;16-channel networked digital video recorder, 120 fps, cold-swappable removable OS HD, 500 GB usable RAID 5 data, hot-swappable HDD, no CD-RW drive, 16x4 analog video matrix, NTSC/EIA and PAL/CCIR
KEX120M-800R5	8980-30	KOLLECTOR ELITE XG SERVER; preloaded ViconNet Ver 3;16-channel networked digital video recorder, 120 fps, cold-swappable removable OS HD, 800 GB usable RAID 5 data, hot-swappable HDD, no CD-RW drive, 16x4 analog video matrix, NTSC/EIA and PAL/CCIR
KEX120M-1200R5	8980-40	KOLLECTOR ELITE XG SERVER; preloaded ViconNet Ver 3;16-channel networked digital video recorder, 120 fps, cold-swappable removable OS HD, 1200 GB usable RAID 5 data, hot-swappable HDD, no CD-RW drive, 16x4 analog video matrix, NTSC/EIA and PAL/CCIR
KEX240M-300	8952-01	KOLLECTOR ELITE XG SERVER; preloaded ViconNet Ver 3; 16-channel networked digital video recorder, 240 fps, internal OS HD, 300 GB data HD and CD-RW drive, 16x4 analog video matrix, NTSC/EIA and PAL/CCIR
KEX240M-660	8995-01	KOLLECTOR ELITE XG SERVER; preloaded ViconNet Ver 3; 16-channel networked digital video recorder, 240 fps, internal OS HD, 600 GB data HD and CD-RW drive, 16x4 analog video matrix, NTSC/EIA and PAL/CCIR
KEX240M-900	8953-01	KOLLECTOR ELITE XG SERVER; preloaded ViconNet Ver 3;16-channel networked digital video recorder, 240 fps, internal OS HD, 900 GB data HD and CD-RW drive, 16x4 analog video matrix, NTSC/EIA and PAL/CCIR
KEX240M-1200	8954-01	KOLLECTOR ELITE XG SERVER; preloaded ViconNet Ver 3; 16-channel networked digital video recorder, 240 fps, internal OS HD, 1.2 TB data HD and CD-RW drive, 16x4 analog video matrix, NTSC/EIA and PAL/CCIR
KEX240M-1600	8997-01	KOLLECTOR ELITE XG SERVER; preloaded ViconNet Ver 3; 16-channel networked digital video recorder, 240 fps, internal OS HD, 1.6 TB data HD and CD-RW drive, 16x4 analog video matrix, NTSC/EIA and PAL/CCIR
KEX480M-250	8956-01	KOLLECTOR ELITE XG SERVER; preloaded ViconNet Ver 3;16-channel networked digital video recorder, 480 fps, internal OS HD, 250 GB data HD and CD-RW drive, 16x4 analog video matrix, NTSC/EIA and PAL/CCIR
KEX480M-1200	8957-01	KOLLECTOR ELITE XG SERVER; preloaded ViconNet Ver 3; 16-channel networked digital video recorder, 480 fps, internal OS HD, 1.2 TB data HD and CD-RW drive, 16x4 analog video matrix, NTSC/EIA and PAL/CCIR
KEX480M-1600	8998-01	KOLLECTOR ELITE XG SERVER; preloaded ViconNet Ver 3; 16-channel networked digital video recorder, 480 fps, internal OS HD, 1.6 TB data HD and CD-RW drive, 16x4 analog video matrix, NTSC/EIA and PAL/CCIR

Table 1: Models, Product Codes and Descriptions

Compression Type	Resolution and Compression Rate							
	1 (Frame) 720 x 480 (864 x 586 PAL)	2 (Frame) 720 x 488 (864 x 586 PAL)	3 (Field) 720 x 244 (864 x 293 PAL)	4 (Field) 720 x 244 (864 x 293 PAL)	5 (CIF) 360 x 244 (432 x 293 PAL)	6 (CIF) 360 x 244 (432 x 293 PAL)	7 (HCIF) 360 x 122 (432 x 146 PAL)	8 (HCIF) 360 x 122 (432 x 146 PAL)
	High	Low	High	Low	High	Low	High	Low
FULL (JPEG)	Largest Picture Best Quality Full Refresh	Largest Picture Excellent Quality Full Refresh	Large Picture Very Good Quality Full Refresh	Large Picture Good Quality Full Refresh	Medium Picture Average Quality Full Refresh	Medium Picture Fair Quality Full Refresh	Small Picture Low Quality Full Refresh	Small Picture Very Low Quality Full Refresh
NORMAL (MPEG4)	Largest Picture Best Quality Periodic Refresh	Largest Picture Excellent Quality Periodic Refresh	Large Picture Very Good Quality Periodic Refresh	Large Picture Good Quality Periodic Refresh	Medium Picture Average Quality Periodic Refresh	Medium Picture Fair Quality Periodic Refresh	Small Picture Low Quality Periodic Refresh	Small Picture Very Low Quality Periodic Refresh

Table 2: Collector Elite Video Quality

Product Specification

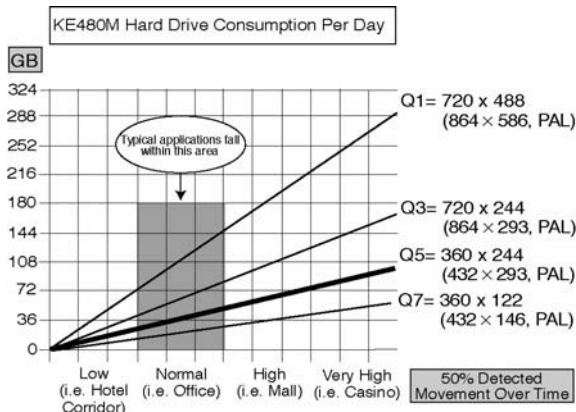
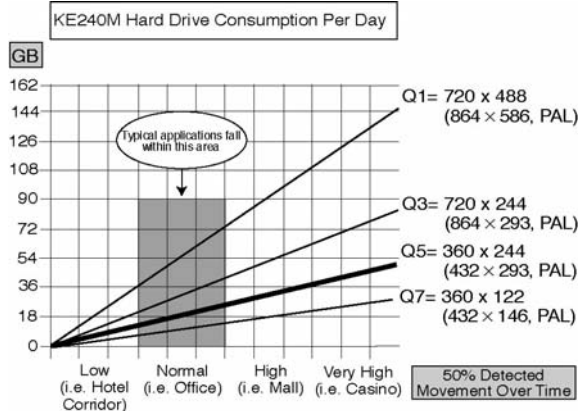
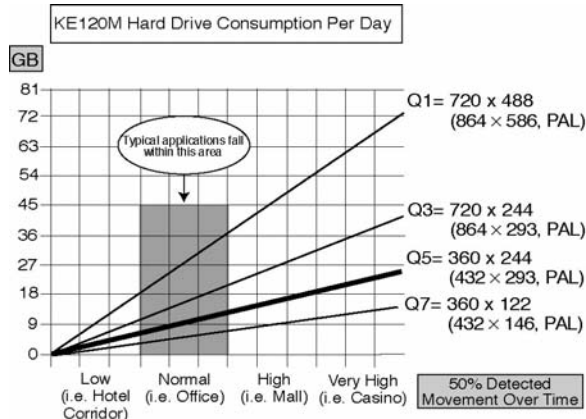

Model Number	Internal HDD Size (GB)	With VN-RAIDA-8-250		With VN-RAIDA-16-250	
		Effective RAID HDD Size (GB) Space (GB)	Approximate Days Recording	Effective RAID HDD Size (GB) Space (GB)	Approximate Days Recording
KEX120M-250	250	1750	120	3750	130
KEX240M-300	300	1750	60	3750	65
KEX480M-250	250	1750	30	3750	32

Note: This table is based on the following conditions:

- 24 hours normal activity with 50% detected
- Normal compression.
- Quality Q5 (360 x 244 pixels, 432 x 293, PAL).
- Recording durations may vary based on actual scene
- Recording data does not include audio data (0.4 GB/12 hour)

Note: When a RAID is available, it is recommended to have all the database on the RAID drives and not on the Collector drives (use the minimal internal drive size). This will ensure the highest level of protection for the data. Units with internal RAID consume the same storage as those with a regular internal hard drive.

Table 3: Sample Recording Time on Collector with RAID (RAID units are available in different sizes)

Product Specification

ELECTRICAL

Input Voltage: 120 – 230 VAC +/- 10%, 50/60 Hz nominal.

Note: Vicon requires the use of uninterruptible power supply systems (UPS) to prevent voltage fluctuations that can affect operation and cause damage to the equipment. Failure to comply voids the warranty.

Current: 3 A.

Power Consumption: 450 Watts nominal.

Heat Equivalent: 25.6 btu/min (6.4 kg-cal/min).

Note: These figures represent the conversion of 100% of the electrical energy to heat. Actual percentage of the heat generated will be less and will vary from product to product. These figures are provided as an aid in determining the extent of cooling required for an installation.

System: **CPU:** Intel® Pentium IV 2.66 GHz, minimum (3.0 GHz on 480 models).
RAM: 512 MB (1 GB on 480 models).
HDD: 200 – 1600 GB. Based on model. (See Table 1.)
LAN Card: 100/1000 Mbps TPO.

Connector Types/

Quantities: **Analog Video Inputs:** 16 BNC-F.
Analog Video Loopouts: 16 in 2 DB-15 connectors.
Power: 1 standard 3-conductor female socket.
VGA Video Output: Dual output (VGA/DVI).
Analog Video Output: S-Video connector and provided adapter cable.
Sensor Input Port: 16 NO/NC connectors, software selectable.
PTZ Control Port: 1 4-pin terminal block serial port using RS-422 protocol for all 16 channels. Also, connections available through the 16 connectors.
Network Port: RJ-45 jack, female.
Keyboard Port: 5-pin DIN jack (PS2).
Mouse Port: 5-pin DIN jack (PS2).
Peripheral Port: 2 USB ports used for connection of printers and other peripherals.
16 x 4 Matrix: Allows switching any of the local inputs to 4 local outputs. Switcher is controlled through software locally and over the network. Also can be controlled as part of a macro.

Video Level Input: 1.0 V peak-to-peak (140 IRE) nominal.
Luminance: 100 IRE +/- 15%.
Sync: 40 IRE +/- 15%.
Colorburst: 40 IRE +/- 15%.

Video Input

Impedance: All BNC connectors: 75 ohms.

Video Formats

Supported: NTSC, PAL, EIA and CCIR.

Video Recording

Rate: 16 simultaneous channels @ 120, 240 or 480 frames per second, maximum. 30 fps per channel, maximum.

Video Recording

Resolution: 480 horizontal TV lines maximum at 720 x 488 pixel palette; 864 x 586, PAL.

Video Quality: Selectable using a 4-position bar, from the Main Screen. There are 4 levels of resolution (Frame, Field, CIF, HCIF) with 2 levels of compression (Normal, Full) comprising 8 quality levels total, accessible from the Setup menu selections. Normal is Optimized-MPEG4 and Full is JPEG compression, see Table 2.

Analog Video Quality: Matrix output: 250 HTVL nominal.

S-Video output: 300 HTVL nominal.

Audio Input: Microphone should be 0 dbm, 32 KHz bandwidth, 600 ohm impedance, 2 V RMS (1 V p-p) output.

Audio Sampling Rate: 8 KHz/sec/channel.

Audio Data

Storage Rate: Approximately 0.4 GB/12-hour day/microphone.

CD-RW Drive: Internal CD-RW drive; optional DVD. Not available on internal RAID models.

Camera to Recorder

Analog Input

Video Transmission

Distance (coaxial cable distance): 1000 ft (305 m) nominal.

Alarm Input Type: Each alarm input is automatically configured as a normally opened (NO) or normally closed (NC) trigger.

Alarm Output: 8 relay outputs.

VGA Monitor Output: SVGA, True-Color Mode with a minimum resolution of 1024 x 768. Includes a secondary monitor output.

VGA Video

Display Modes: Multi-screen Display Mode for both live and Video Playback of 1, 4, 6, 9, 16 cameras.

Panel Indicators: 1 red power LED used for power status indication.
 1 green LED used for floppy disk indication.
 16 green LEDs used for camera detection and recording status.
 16 red LEDs used for device detection and alarm status.

Panel Key Lock: Key lock provided on front panel to secure all controls.

SOFTWARE OPERATION

Main Window Screen: A multi-channel display area containing up to 16 connected cameras and microphones, all necessary controls to operate and setup the system.

Graphical Map: Supports realistic camera location (a workstation with a dual output VGA will allow showing the Map on a dedicated monitor while viewing video on the other).

Site and Device Tree: A physical list of all known network site areas and connected cameras, PTZ cameras, and microphones.

Quick Playback: Start video playback of live camera with a few clicks.

Play from Time: Call up images from any database on the network from Main Screen.

Navigator Window: A graphical display of recorded video. It contains a set of function buttons used to access the video on-screen.

Control Dialog

Display Area: A space to work in conjunction with the Other Controls Area.

Toolbar: An area providing access to all major functionality of the system.

Display Mode

Control Area: A palette of buttons to set the picture quality (resolution) and refresh mode of live video display.

Function Control

Area: A palette of controls used to enable or disable the video recording as well as any currently running macros in the system.

Video Display

Controls Area: A palette of buttons used to set the picture quality and resolution of the recorded and networked video. A 4-position bar allows the quality setting.

Other Controls

Area: A palette of buttons that activate when a valid device is selected from the Site and Device Tree.

System

Configuration: A Main Settings Menu used for setup of devices, authorization and all other system functions.

Network and

Sites Configuration: The network portion of this feature allows setup of all IP address information and a system Nucleus and Backup Nucleus.

Macro Configuration: Macros can be defined for recorded or displayed cameras, microphones, and related devices (sensors).

Device Configuration: Devices can be configured for system recognition and operation.

Authorization

Rights Setup: Group rights can be configured by specific site. Rights provide authority to perform all system functions.

Alarm Configuration: Alarms can be programmed to annunciate under special conditions.

Storage Database

Utilities: This utility allows setup and usage of detected hard disks locally.

Authentication: Video authentication is established by site and affects display of destination video.

Macro Function: System can be setup to perform routines of record and playback and alarm in a dedicated screen setup menu.

Log Reporting: Continuously running activity log.

Schedule Function: System can be set to record and display a video "tour" of multiple channels.

Central Failure

Notification (CFN): Sends notifications indicating certain applications have failed.

Recording Verification

System (RVS): Ensures continuous recording by notifying any recording errors.

Product Specification

MECHANICAL

Application: Indoor.

Mounting: Standard 19 in. (483 mm) rack mount and stackable, 4U height.

Dimensions: Height (H): 7.0 in. (178 mm).

Width (W): 19.0 in. (483 mm).

Depth (D) 120 fps: 22.0 in. (559 mm).
240/480 fps: 24.25 in. (616 mm). See Figure.

Note: Dimensions exclude connectors and rack mount handles.

Weight: 50.0 lb (22.6 kg), approximately.

Construction: Steel case and hardware.

Color: Black.

Shipping

Dimensions: Length: 28.5 in. (723 mm).

Width: 24 in. (610 mm).

Height: 12 in. (305 mm).

Shipping Weight: 63 lb (28.5 kg), approximately.

Shipping Volume: 4.75 ft³ (0.13 m³).

ENVIRONMENTAL

Unit Operating

Temperature Range: 32 to 104° F (0 to 40° C).

Unit Operating

Humidity Range: 0 to 95% relative, non-condensing.

Ideal Room

Temperature Range: 66 to 75° F (19 to 25° C).

Ideal Room

Humidity Range: 80% relative, non-condensing.

Maximum Room

Temperature Range: 50 - 86° F (10 - 30° C).

Storage

Temperature Range: -4 to 158° F (-20 to 70° C).

Storage

Humidity Range: 0 to 95% relative, non-condensing.

Product Specification

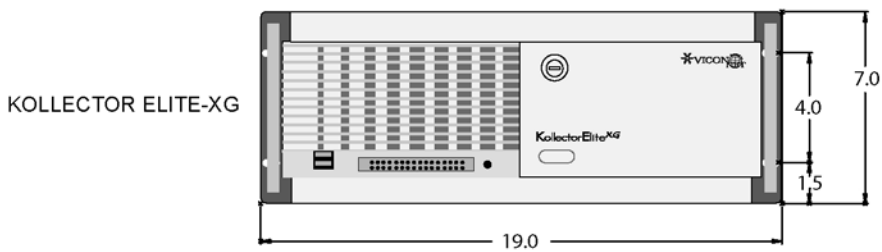
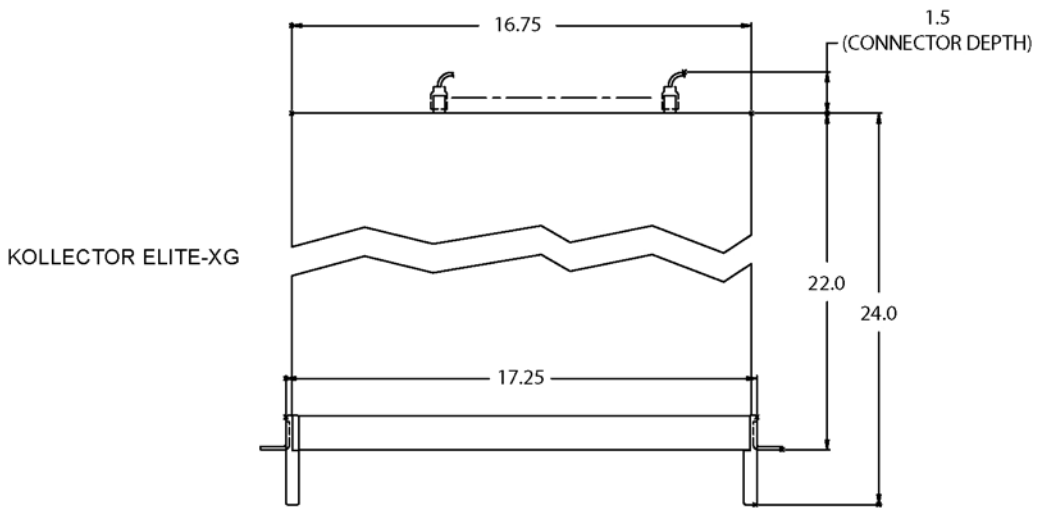
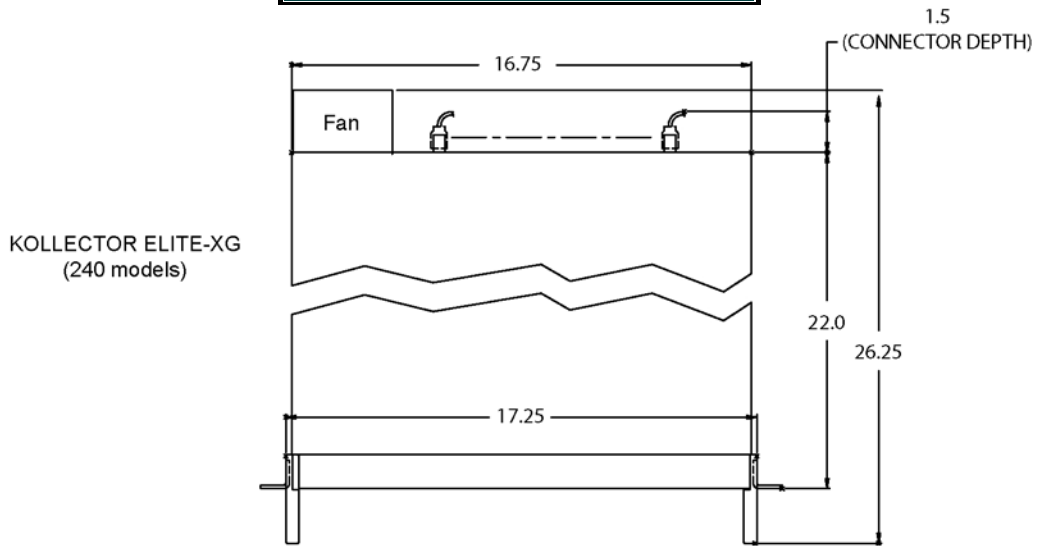

Product Specification

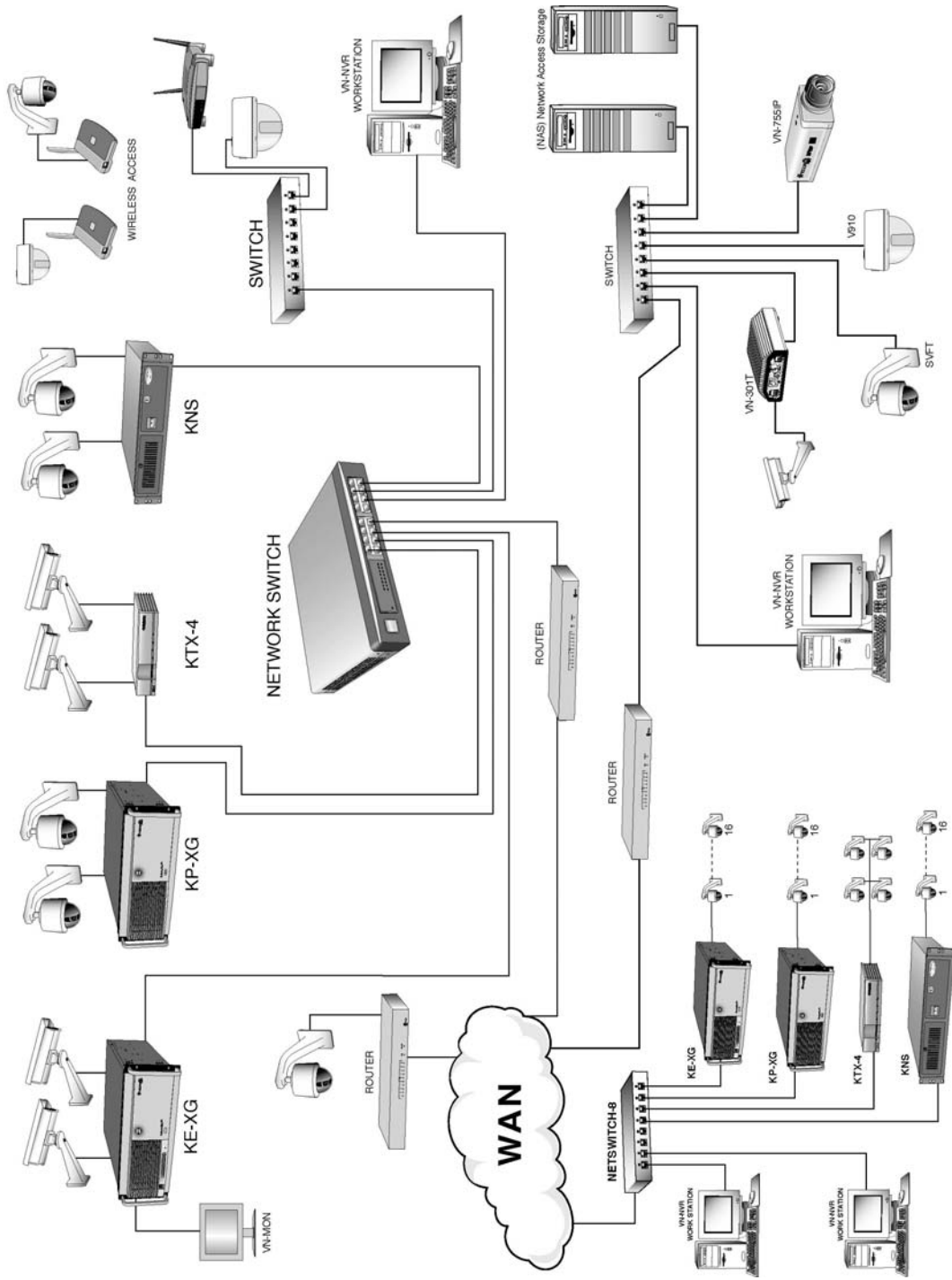

89 Arkay Drive
Hauppauge, NY 11788
www.vicon-cctv.com

TEL: 631-952-2288
FAX: 631-951-2288
TOLL FREE: 800-645-9116