

## Genesis Receivers and Control Units.

### LGMT434. Masthead Receiver.



LGMT434. Masthead Only

The Genesis Masthead Receiver is weather proof to IP66 and forms the heart of a Genesis Wireless system. Its purpose is to receive alarm data from the PIR's and pass it to a control unit via an RS232 link.

A Masthead can transmit data as well as receive it, which means it will transmit back to a Walk Test Instrument to show all received information as well as the signal strength at the masthead. In this way the installer knows that the detector is working correctly and also that it is being received by the system. In addition, it can perform as a repeater for systems that require greater transmission operating distances. Up to seven repeaters can be used in any one system to provide transmission range of several kilometres. Finally, the Masthead can be programmed with individual names for each unit number which are transmitted to the walk test instrument or pager to aid location of the detector. An optional aerial (AE434) may be used instead of the supplied aerial for improved reception.

### LGRU16 & LGRU16ELR. Relay Units 16 Alarms & 16 Tamper.

The LGRU16 & LGRU16ELR control interface relay units provide physical alarm and tamper outputs for DVR and Alarm systems.

The LGRU16 is supplied with one LGRM8 relay module which provides 8 alarm and 8 tamper relay contacts that can be interfaced to virtually any alarm system. A further LGRM8 module can be added to increase it to 16 alarm and 16 tamper outputs. Between one and four LGRU16 relay units can be connected with a single masthead receiver to provide the maximum of 64 alarm and 64 tamper contacts. The LGRU16ELR version has screw terminals and End Of Line Resistors built in. The resistor values are plug-in modules and may be changed accordingly. On the front panel, a display shows information on alarms, faults and tamper which are held in the log. The PIR's call in periodically and are monitored individually. If they fail to call in, a tamper will occur. An additional RS232 text output provides alarm and other information that can be inserted on a video picture for remote viewing.

### LGDM16. Plug & Play interface to DM's DS2 DVR.

This alternative to the LGRU16 unit provides a direct Plug & Play interface to a Dedicated Micros DS2 DVR without the need for RAM modules.

A Masthead receiver receives the data from the PIR detectors and passes it to the LGDM16 control unit in the form of RS232 text messages. The LGDM16 then converts the data into the Dedicated Micros protocol on RS485 to provide 16 alarm and 16 tamper outputs. Between one and four LGDM16 interface units can be connected with a single masthead receiver to provide up to 64 alarm and 64 tamper commands that can be interfaced to a DS2. On the front panel, a display shows information on alarms, faults and tamper which are held in a log. The PIR's call in periodically and are monitored individually. If they fail to call in, a tamper will occur. An additional RS232 text output provides alarm and other information that can be inserted on a video picture for remote viewing.

### LGMRU4x4. Masthead Receiver with Relays.

This alternative to the LGMT434 Masthead Receiver but has the addition of relay outputs which can be connected directly to the alarm pre-sets of a PTZ camera.

The unit provides either 4 alarm outputs with corresponding tamper outputs or eight alarm outputs without tamper. DIL switches set the different modes as well as the unit code groups. Expansion units are available to increase the number of alarm outputs. There is no limit to the number of LGMRU4x4 units that can be used on any one system. This unit can transmit information as well as receive it which means it will transmit back to a Walk Test Instrument to show all received information as well as signal strength back at the masthead. In this way the installer knows that the detector is working correctly and also that it is being received by the system. In addition, it can perform as a repeater for systems that require greater transmission operating distances. An optional aerial (AE434) may be used instead of the supplied aerial for improved reception.



LGMRU4x4. 4 Alarms 4 Tamper

## Genesis Accessories.

### LGRM8 & LGRM8ELR. Relay Modules.

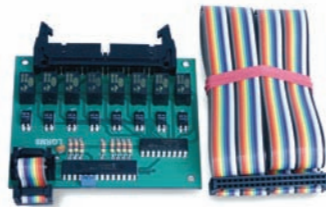

LGRM8. For LGRU16

The LGRM8 & LGRM8ELR relay modules can be fitted to an LGRU16 or LGRU16ELR to provide an extra 8 alarm and 8 tamper contacts.

The LGRM8 relays provide eight Normally Closed tamper contacts and eight Change Over alarm contacts. This module is supplied with a one metre ribbon cable which can be easily stripped back for individual connection to alarm inputs. The LGRM8ELR version has screw terminals and End Of Line Resistors which can be plugged in as modules. It is possible to connect up to four LGRU16's together to provide the maximum of sixty four alarm and 64 tamper outputs from a system.

### LGWT434. Walk Test Instrument.

The Genesis Walk Test Instrument is a Transceiver that has the ability to receive signals directly from the PIR detectors or via the Masthead. It can also transmit to simulate a PIR in order to check proposed PIR positions before installation begins.

An LCD shows PIR information such as ID number, Lens type, Pulse count setting, signal strength and battery condition. In addition, the display can also show an alpha numeric name for each PIR which makes identification easier.



Walk Test Instrument

### LGTX434. Wireless Genesis Transmitter.

The LGTX434 transmitter module enables other detection products to interface with the Genesis Wireless system such as Active Infra Red Beams and Door Contacts.

The module is powered from batteries and has a special regulator that maintains optimum performance even when the batteries have run down. When used with battery beam sets, the LGTX434 will report the battery status of the beam set. Just like the LGWP detectors, this transmitter module poles every minute to inform the system that it is still operational and to advise the battery condition. Available as 12volts / 4.5volts or 3 volts.



LGTX434. For third party products

### AE434. High Efficiency Aerial

Use this aerial with either the LGMT434 Masthead or LGMRU4X4 to achieve maximum reception range.

This external aerial is supplied with a mounting bracket and 5 metres of coaxial cable with 50 ohm BNC connector.



AE434. Optional (longer range) aerial

### LGKS and LGKP. Wireless Key Points.

With all BS8418 Remote Monitored systems it is a requirement that the system should be Set and Un-Set. The Genesis wireless key points provide an easy and convenient solution to the problem.

There are two types of key point in the Genesis range being the static type (LGKS) and the portable type (LGKP). Both types of key points may be used on the same system and there are no limits to the number of key points used on any one system. Both Key Points are powered by a 9 volt battery which will last for two years with average daily use. The receiver is the same receiver that is used for the Genesis wireless PIR detectors and therefore this cost is already bourn in the system. A small module which is supplied with the Key Point is then plugged on to the receiver which provides relay contacts.



LGKP. Portable

LGKS. Static. IP65



# The Genesis Wireless PIR System

BS8418 Compliant

Miles ahead of the rest...  
Transmits over several km



# Setting new standards for PIR detection

## The Genesis Wireless PIR System

BS8418 compliant

**1km Transmission Range**

*Can be repeated over several km*



**WIRELESS PIRs**  
up to 64 battery powered PIR's can transmit back to one Masthead. Transmission range at least 1km.)



**WALK TEST INSTRUMENT**  
receives either directly from the PIR or via the Masthead



**MASTHEAD RECEIVER**  
receives data from the PIRs and communicates with the control unit



**CONTROL INTERFACE**  
monitors all PIRs and passes alarms to a DVR or alarm system



**The GENESIS range of Wireless Passive Infra Red Detectors and accessories have been designed to meet the latest and most demanding requirements of the CCTV market.**

These detectors provide the versatility of wireless whilst meeting and surpassing the requirements of the BS8418 standard. Radio transmission is secure by way of encrypted rolling codes with regular call ins to inform the system that each PIR is still operational. Up to 64 PIR's can be used on each system and may be a mixture of wired and wireless versions.

In addition, there are 32 site codes to choose from which enable many systems to work independently in the same vicinity. Transmission range is exceptional at over 1km line of sight and several kilometres when used with repeaters. Various Control Interfaces provide a means of connecting the alarms to DVR's and alarm systems. Some popular makes of DVR have Plug & Play connection for even easier installation. For further detailed information and to see a full of latest products in the Genesis range, please visit our web site.

## Genesis Wireless PIR Detectors

**LGWP3020**  
LONG WIDE RANGE

**LGWP1520**  
MEDIUM WIDE RANGE

**LGWP4004**  
LONG NARROW RANGE

**LGWP12HC**  
HORIZONTAL CURTAIN

**LGWP12VC**  
VERTICAL CURTAIN



The detachable sun shield shown here is optional.

**The LGWP range of Wireless Passive Infra Red Detectors (PIR) allow fast, flexible installations with low maintenance and costs.**

Genesis uses sophisticated signal processing and optics to minimise nuisance alarms caused by the sun, shadows and reflections as well as loose fluttering materials. Battery life is around two years battery life of around two years which is achieved by a special regulator that maintains optimum performance while the batteries are running down.

Day light and thermal sensors provide automatic compensation in varying climate conditions and there is a shock sensor for detecting physical attack as well as a sensor for anti-masking (cloak).

Supervision is achieved by periodic polling to the receiver whilst reporting battery condition, lens type, sensitivity settings and software version.

The new 3020 detector has these additional features: Infra Red anti-masking, 3 axis acceleration sensor and twin dual element pyroelectric sensors with mirror/lens optics.

There is the additional feature of AB logic to provide extra filtering. For maximum sensitivity, an alarm is generated if either zones A or B are crossed but for an extra degree of filtering an alarm can only be generated if A followed by B or B followed by A is crossed.

SPECIFICATION:	LGWP3020	LGWP1520	LGWP4004	LGWP12HC	LGWP12VC
BS8418	✓	✓	✓	✓	✓
Grade 2 EN50131-1	✓	X	X	X	X
Guarantee: 2 years	✓	✓	✓	✓	✓
Battery life: 2 years	✓	✓	✓	✓	✓
Mounting height: 2.5 - 4.0m	✓	✓	✓	✓	✓
Enclosure tamper	✓	✓	✓	✓	✓
Shock sensor	✓	✓	✓	✓	✓
Anti masking (Cloak)	Infra red	Visible light	Visible light	Visible light	Visible light
3 Axis orientation sensor	✓	X	X	X	X
Pyro sensors	Twin dual	Single dual	Single dual	Single dual	Single dual
Mirror optics	✓	X	X	X	X
Temperature compensation	✓	✓	✓	✓	✓
Day light compensation	✓	✓	✓	✓	✓
Periodic polling	✓	✓	✓	✓	✓
Transmission range and type: 1Km Pan European UHF FM	✓	✓	✓	✓	✓
License exempt	✓	✓	✓	✓	✓
Enclosure: Weatherproof to IP66. 3mm polycarbonate.	✓	✓	✓	✓	✓
Temperature range: -10 deg C +60 deg C.	✓	✓	✓	✓	✓
Dimensions: H183mm x W130mm x D187mm.	✓	✓	✓	✓	✓

## Genesis Zone Patterns

**There are currently five popular lens patterns to choose from:**

- Long Wide Range (LGWP3020)  
Provides coverage of 30 metres out by 20 metres across.
- Medium Wide Range (LGWP1520)  
Provides coverage of 15 metres out by 20 metres across.
- Long Narrow Range (LGWP4004)  
Provides coverage of 40 metres out by 4.5 metres across. This is ideal for perimeter coverage.
- The horizontal and vertical Curtain types (LGWP12HC) and (LGWP12VC) are just flat fan shaped patterns without the intermediate zones. These are used to look along fence lines or down the sides of a buildings. If the horizontal version is set to look straight ahead, animals will be able to wander underneath the detection zone without causing nuisance alarms.

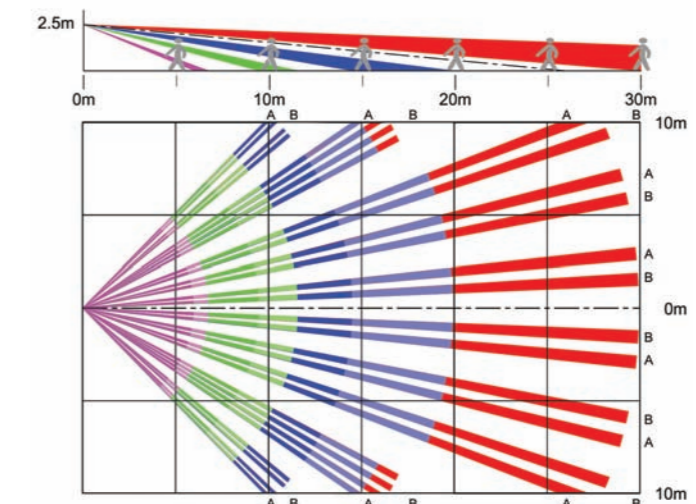
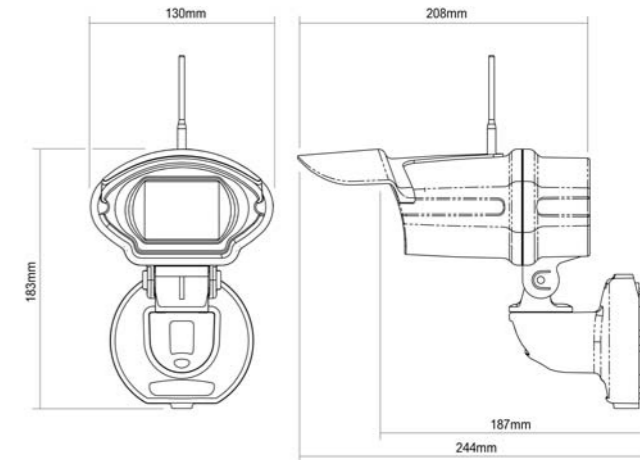

**LGWP3020 ZONE PATTERN**  
LONG WIDE RANGE

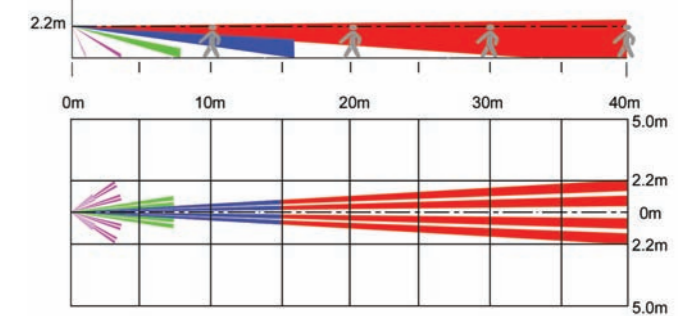

**LGWP4004 ZONE PATTERN**  
LONG NARROW RANGE

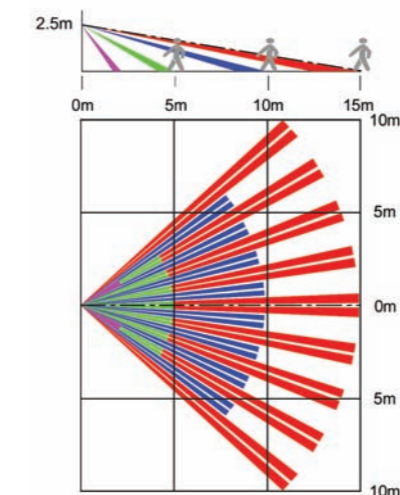

**LGWP1520 ZONE PATTERN**  
MEDIUM WIDE RANGE

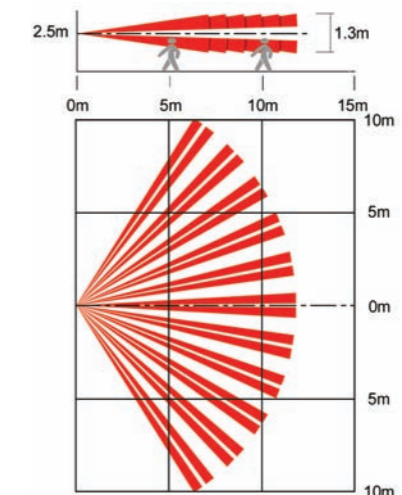

**LGWP12HC ZONE PATTERN**  
HORIZONTAL CURTAIN

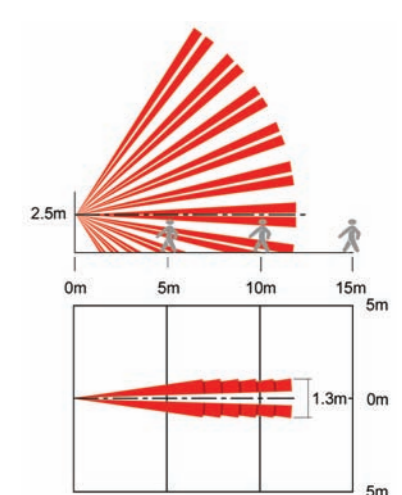

**LGWP12VC ZONE PATTERN**  
VERTICAL CURTAIN