

## DS-M5504HMI Series Mobile DVR

### Introduction:

Adopting embedded Linux operating system, Hikvision DS-M5504HMI series dedicated Mobile DVR (Digital Video Recorder) provides powerful monitoring functionalities, including audio and video encoding & decoding, 2G & 3G & Wi-Fi wireless network transmission, satellite positioning service, secure data storage, hard disk vibration damping. It can both work alone as a recorder and cooperate with other devices to build a comprehensive surveillance system.

Thanks to the features of high stability, easy-to-carry and low power consumption, the DS-M5504HMI series Mobile DVR is widely applied to the surveillance projects of public transportation, school bus, etc.



### Available Models:

DS-M5504HMI series; DS-M5504HMI/BNC series



- The Wi-Fi function is only supported by the “/WT” devices.
- The 3G dialing function is only supported by the “/GW” devices.
- The 2G network function is only supported by the “/GG” devices.

### Main Features:

- User-friendly GUI providing easy and flexible operations
- Standard 1DIN dimensions, supporting embedded and bracket installation
- Pluggable 3G (WCDMA), Wi-Fi (optional), and 2G (optional) module providing flexible data transmission solutions
- pluggable GNSS (Global Navigation Satellite System) module precisely positioning the vehicle via the satellite and recording the location information in the stream
- 4 analog channels of audio & video inputs connectable; each channel supporting up to WD1 resolution with H.264 encoding technology
- one 2.5-inch HDD/SSD and one SD/SDHC card pluggable, adopting hard disk vibration damping technology
- Information collection interfaces collecting driving information such as left/right turn, braking, backing up, etc.
- Hard disk box with USB interface supporting intelligent temperature control and data export
- Specialized aviation connectors ensuring signal stability
- Delay (0~6h) shutdown and 24-hour scheduled startup/shutdown
- Wide-range power input (+8VDC ~+36 VDC)
- Power-off protection avoiding key data from loss
- Tensile aluminum chassis with no fan design well adaptable to working environment
- Software-based firewall supported

© 2014 by HIKVISION. All rights reserved.

### Physical Interfaces:

#### Front Panel

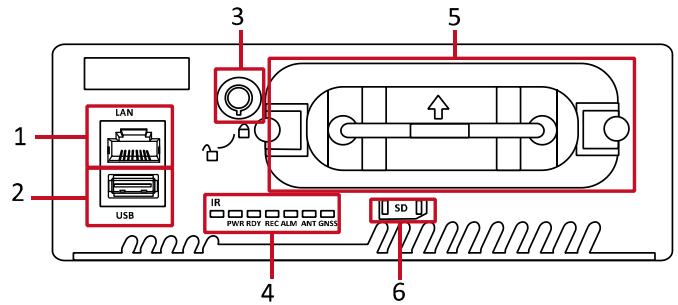

Index	Name	Description
1	LAN	10M/100M self-adaptive Ethernet interface
2	USB	USB interface
3	Hard disk lock	Lock/Unlock the hard disk box.
4	Indicators	<b>IR: IR Receiver</b> Receive IR signal from remote control.
		<b>PWR: Power indicator</b> Light in green after device startup; light in red when device standby.
		<b>REY: Ready indicator</b> Light in green after device starts up properly.
		<b>REC: Record indicator</b> Light in green during recording process.
		<b>ALM: Alarm indicator</b> Light in red when alarm occurs.
		<b>ANT: 3G dialing indicator</b> Light in steady green during dialing process; flash in green after dialing succeeded; The light is out when the dialing module is abnormal.
5	Hard disk box	GNSS: GNSS indicator Light in steady green during positioning process; flash in green after positioning succeeded; The light is out when the positioning module is abnormal.
		Insert one 2.5-inch SATA HDD/SSD for data storage.
6	SD card slot	Insert one SD card for data storage.

## Rear Panel of DS-M5504HMI series

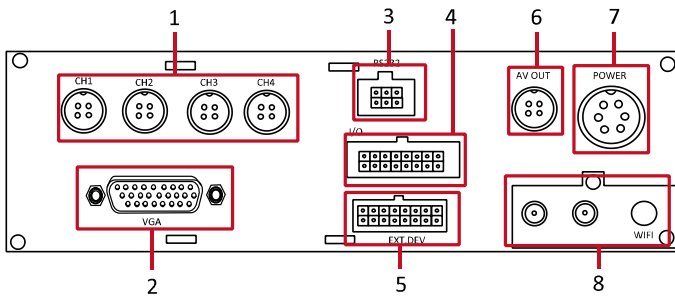

Index	Name	Description
1	<b>CH1~CH4</b>	4-pin aviation plug, audio & video input of channel 1~4, providing 12V power supply
2	<b>VGA</b>	VGA interface
3	<b>RS232</b>	RS-232 interface
4	<b>I/O</b>	7-ch high / low level signal trigger including 3-ch alarm inputs, 4-ch sensor in; 1-ch pulse signal input
5	<b>EXT.DEV</b>	RS-422 communication interface, two-way audio, video output signal, RS-485 and power supply
6	<b>AV OUT</b>	4-pin aviation plug for audio & video output
7	<b>POWER</b>	6-pin aviation plug for power supply and start control
8	<b>Pluggable Module</b>	3G module, Wi-Fi module (optional), 2G module (optional), GPS module

## Rear Panel of DS-M5504HMI/BNC series

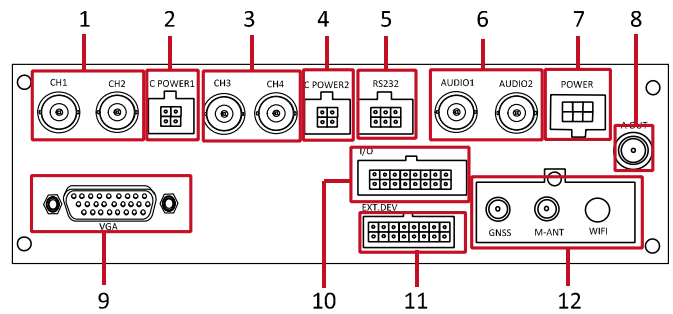

Index	Name	Description
1	<b>CH1~CH2</b>	BNC interface; video input of channel 1~2
2	<b>C POWER1</b>	Provide power supply for connected camera
3	<b>CH3~CH4</b>	BNC interface; video input of channel 3~4
4	<b>C POWER2</b>	Provide power supply for connected camera
5	<b>RS232</b>	RS-232 interface
6	<b>AUDIO1</b> <b>AUDIO2</b>	Audio input of channel 1~2 (no audio input supported for channel 3~4)
7	<b>POWER</b>	Provide power supply
8	<b>AV OUT</b>	BNC interface for video output
9	<b>VGA</b>	VGA interface
10	<b>I/O</b>	7-ch high / low level signal trigger including 3-ch alarm inputs, 4-ch sensor in; 1-ch pulse signal input
11	<b>EXT.DEV</b>	RS-422 communication interface, two-way audio, video output signal, RS-485 and power supply
12	<b>Pluggable Module</b>	3G module, Wi-Fi module (optional), 2G module (optional), GPS module



- Part function is optional. For details, see the actual device model.
- Pin definition of aviation plugs is for reference only. For details, see the tag on the corresponding component.

**Specifications 1: DS-M5504HMI series:**

Model		DS-M5504HMI series
Video/Audio input	Analog video input	4-ch
		Aviation plug (1.0 Vp-p, 75 Ω), PAL / NTSC self-adaptive
	Audio input	4-ch Aviation plug (linear level, 1kΩ)
	IP video input	None
Video/Audio output	VGA output	1-ch Resolution: 1920×1080, 1280×1024, 1280×720, 1024×768
		CVBS output
	Audio output	1-ch; aviation plug (linear level, 600 Ω)
Encoding/Decoding parameters	Video compression	H.264
	Encoding resolution	Main stream: WD1 / 4CIF / 2CIF / CIF
		Sub stream: CIF / QCIF
	Frame rate	PAL: 1~25fps; NTSC: 1~30fps
	Video bitrate	32Kbps~2Mbps; custom (Max.: 4Mbps)
	Audio compression	G.711
	Audio bitrate	16Kbps
	Stream type	Video, Video & Audio
Dual stream	Supported	
Hard disk	Type	One 2.5-inch SATA HDD/SSD
	Capacity	Up to 1TB capacity supported
	Installation	Pluggable
	Protection	3-generation hard disk box
	Backup	USB interfaces on hard disk box and device front panel supporting data backup
Wireless Network	3G	WCDMA (2G module optional)
	Wi-Fi (optional)	802.11 b/g/n supported, 2.4GHz
Positioning	GNSS	GPS; BDS (optional)
External interface	Two-way audio	G.722
	Alarm in	7-ch high/low level signal input; 1-ch pulse signal input; 3mm connector
	Alarm out	2-ch; 3mm connector
	Network interface	1; RJ45; 10M/100M self-adaptive Ethernet interface
	Antenna interface	SMA interfaces on pluggable module including one for 3G, one for Wi-Fi and one for GPS
	Serial interface	RS-232, RS-485, 3mm connector
	USB port	1 × USB2.0
	SIM card	1, standard SIM card slot
	SD/SDHC card	1, standard SD/SDHC card slot
General	Operating system	Linux
	Operating method	IR remote control
	Power supply	Input: +8~ +36VDC; Output: 12VDC/2A, 5VDC/1A
	Consumption	Standby: Max. 0.5W;



		Full load: Max.20W (without 7-inch screen)
	Working temperature	-10 ℃ ~ +55 ℃ (14 ℉ ~ 131 ℉)
	Working humidity	10%~90%
	Dimensions (W×D×H)	178mm×170mm×50mm
	Weight	Aprox.1.6kg (without hard disk or SD/SDHC card)



**Specifications 2: DS-M5504HMI/BNC series:**

Model		DS-M5504HMI/BNC series
Video/Audio input	Analog video input	4-ch
		BNC interface, PAL / NTSC self-adaptive
	Audio input	2-ch BNC interface; corresponding to CH1, CH2
	IP video input	None
Video/Audio output	VGA output	1-ch Resolution: 1920×1080, 1280×1024, 1280×720, 1024×768
		CVBS output
	Audio output	1-ch; 3mm connector
Encoding/Decoding parameters	Video compression	H.264
	Encoding resolution	Main stream: WD1 / 4CIF / 2CIF / CIF
		Sub stream: CIF / QCIF
	Frame rate	PAL: 1~25fps; NTSC: 1~30fps
	Video bitrate	32Kbps~2Mbps; custom (Max.: 4Mbps)
	Audio compression	G.711
	Audio bitrate	16Kbps
	Stream type	Video, Video & Audio
Dual stream	Supported	
Hard disk	Type	One 2.5-inch SATA HDD/SSD
	Capacity	Up to 1TB capacity supported
	Installation	Pluggable
	Protection	3-generation hard disk box
	Backup	USB interfaces on hard disk box and device front panel supporting data backup
Wireless Network	3G	WCDMA (2G module optional)
	Wi-Fi (optional)	802.11 b/g/n supported, 2.4GHz
Positioning	GNSS	GPS; BDS (optional)
External interface	Two-way audio	G.722
	Alarm in	7-ch high/low level signal input; 1-ch pulse signal input; 3mm connector
	Alarm out	2-ch; 3mm connector
	Network interface	1; RJ45; 10M/100M self-adaptive Ethernet interface
	Antenna interface	SMA interfaces on pluggable module including one for 3G, one for Wi-Fi and one for GPS
	Serial interface	RS-232, RS-485, 3mm connector
	USB port	1 × USB2.0
	SIM card	1, standard SIM card slot
	SD/SDHC card	1, standard SD/SDHC card slot
General	Operating system	Linux
	Operating method	IR remote control
	Power supply	Input: +8~ +36VDC; Output: 12VDC/2A, 5VDC/1A
	Consumption	Standby: Max. 0.5W;

		Full load: Max.20W (without 7-inch screen)
	Working temperature	-10 ℃ ~ +55 ℃ (14 ℉ ~ 131 ℉)
	Working humidity	10%~90%
	Dimensions (W×D×H)	178mm×170mm×50mm
	Weight	Aprox.1.6kg (without hard disk or SD/SDHC card)

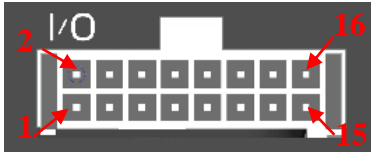
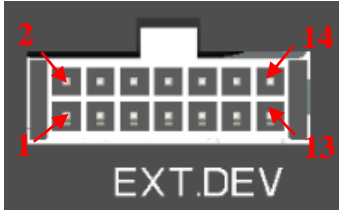
## PIN Definition of DS-M5504HMI series:

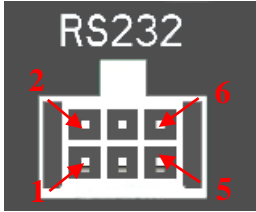
Index	Name	Picture	Details	Note
1	POWER	<p>Model: 16M-6H</p> 	<p>Pin 1: DCIN+</p> <p>Pin 2: DCIN+</p> <p>Pin 3: KEY-</p> <p>Pin 4: DCIN-</p> <p>Pin 5: DCIN-</p> <p>Pin 6: KEY+</p>	<p>Power input: +8~36VDC;</p> <p>KEY+, KEY-: vehicle ignition control signal</p>
2	CH1-CH4 Video input	<p>Model: 12M-4H</p> 	<p>Pin 1: VIN</p> <p>Pin 2: AIN</p> <p>Pin 3: +12V</p> <p>Pin 4: GND</p>	
3	AVOUT	<p>Model: 12M-4H</p> 	<p>Pin 1: VOUT</p> <p>Pin 2: AOUT</p> <p>Pin 3: +12V</p> <p>Pin 4: GND</p>	
4	I/O	<p>Model: 3.0mm indirect connector</p> 	<p>Pin 1, 3, 5, 7: →Alarm in 1~3, sensor in 1</p> <p>Pin 2, 4, 6, 8: →Sensor in 2~5</p> <p>Pin 9, 10→ GND 12V</p> <p>Pin 11,13→Alarm out 1</p> <p>Pin 12, 14→Alarm out 2</p> <p>Pin 15, 16: reserved</p>	<p>7-ch high / low level signal trigger including 3-ch alarm input, 4-ch sensor in; 1-ch pulse signal input</p>
5	EXT.DEV	<p>Model: 3.0mm indirect connector</p> 	<p>Pin 1: RX485+</p> <p>Pin 2: RX485-</p> <p>Pin 3: TX485-</p> <p>Pin 4: TX485+</p> <p>Pin 5: GND</p> <p>Pin 6: VOUT</p> <p>Pin 7: LINE_IN</p> <p>Pin 8: LINE_OUT</p> <p>Pin 9: GND</p> <p>Pin 10: 12V</p> <p>Pin 11: reserved</p> <p>Pin 12: 5V</p>	<p>Supporting RS-422, two-way audio and video output by dedicated connection cable</p>

			Pin 13: reserved Pin 14: reserved	
6	RS232	Model: 3.0mm indirect connector 	Pin 1: GND Pin 2: 5V Pin 3: 232_RXD Pin 4: 232_TXD Pin 5: reserved Pin 6: reserved	Supporting external device connecting or DB9 for debugging by dedicated connection cable
7	Pluggable module		GNSS: GNSS antenna M-ANT: 2G/3G antenna WIFI: Wi-Fi antenna	
8	VGA	Model: DB15 	Pin 1: VIN1 Pin 2: VIN2 Pin 3: VIN3 Pin 4: VIN4 Pin 5: 12V Pin 6: 12V Pin 7: GND Pin 8: GND Pin 9: GND Pin 10: 12V Pin 11: 12V Pin 12: AIN1 Pin 13: AIN2 Pin 14: AIN3 Pin 15: AIN4	

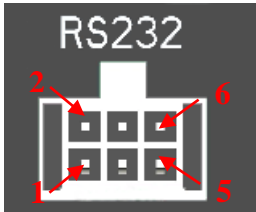
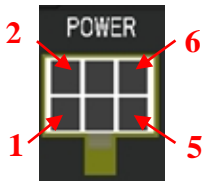
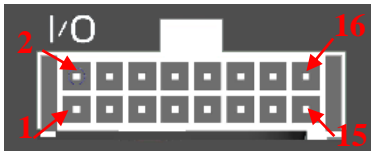
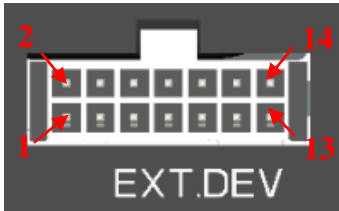

## PIN Definition of DS-M5504HMI/BNC series:

Index	Name	Picture	Details	Note
1	C POWER1 C POWER2	<p>Model: 3.0mm indirect connector</p> 	Pin 1: DCIN- Pin 2: DCIN+ Pin 3: DCIN- Pin 4: DCIN+	Provide power supply for camera(s)
2	RS232	<p>Model: 3.0mm indirect connector</p> 	Pin 1: GND Pin 2: 5V Pin 3: 232_RXD Pin 4: 232_TXD Pin 5: reserved Pin 6: reserved	Supporting external device connecting or DB9 for debugging by dedicated connection cable
3	POWER	<p>Model: 3.0mm indirect connector</p> 	Pin 1: DCIN+ Pin 2: DCIN- Pin 3: DCIN+ Pin 4: DCIN- Pin 5: KEY+ Pin 6: KEY-	
4	I / O	<p>Model: 3.0mm indirect connector</p> 	Pin 1, 3, 5, 7: →Alarm in 1~3, sensor in 1 Pin 2, 4, 6, 8: →Sensor in 2~5 Pin 9, 10→ GND 12V Pin 11,13→Alarm out 1 Pin 12, 14→Alarm out 2 Pin 15, 16: reserved	7-ch high / low level signal trigger including 3-ch alarm input, 4-ch sensor in; 1-ch pulse signal input
5	EXT.DEV	<p>Model: 3.0mm indirect connector</p> 	Pin 1: RX485+ Pin 2: RX485- Pin 3: TX485- Pin 4: TX485+ Pin 5: GND Pin 6: VOUT Pin 7: LINE_IN Pin 8: LINE_OUT Pin 9: GND Pin 10: 12V Pin 11: reserved Pin 12: 5V Pin 13: reserved Pin 14: reserved	Supporting RS-422, two-way audio and video output by dedicated connection cable

6	VGA	<p>Model: DB15</p>  <p>VGA</p>	<p>Pin 1: VIN1 Pin 2: VIN2 Pin 3: VIN3 Pin 4: VIN4 Pin 5: 12V Pin 6: 12V Pin 7: GND Pin 8: GND Pin 9: GND Pin 10: 12V Pin 11: 12V Pin 12: AIN1 Pin 13: AIN2 Pin 14: AIN3 Pin 15: AIN4</p>	
---	-----	---	---	--