

DH-SD63220I/230I-HC

2Mp 20x/30x Full HD HDCVI PTZ Dome Camera



Features

- 20x/30x optical zoom
- Max. 25/30fps@1080P(1920×1080) & 50/60fps@720P resolution
- DWDR, Day/Night(ICR), Ultra DNR, Auto iris, Auto focus
- Control over coaxial cable, long distance real-time transmission
- HD and SD switchable
- Max 300°/s pan speed, 360° endless pan rotation
- Up to 255 presets, 5 auto scan, 8 tour, 5 pattern
- Built-in 2/1 alarm in/out
- Support intelligent 3D positioning with DH-SD protocol
- IP66, OSD

DH-SD63220I/230I-HC

Technical Specifications

Model	DH-SD63220I-HC	DH-SD63230I-HC
Camera		
Image Sensor	1/2.8" Exmor CMOS	
Effective Pixels	1920(H) x 1080(V), 2 Megapixels	
Scanning System	Progressive	
Electronic Shutter Speed	1/1 ~ 1/30,000s	
Min. Illumination	Color: 0.05Lux@F1.4; B/W: 0.005Lux@F1.4	Color: 0.05Lux@F1.6; B/W: 0.005Lux@F1.6
S/N Ratio	More than 55dB	
Resolution	25/30fps@1080P, 25/30/50/60fps@720P	
Video Output	1-channel BNC HDCVI high definition video output/ CVBS standard definition video output (Can switch)	
Camera Features		
Day/Night	Auto(ICR) / Color / B/W	
Backlight Compensation	BLC / HLC / DWDR (Digital WDR)	
White Balance	Auto, ATW, Indoor, Outdoor, Manual	
Gain Control	Auto / Manual	
Noise Reduction	2D/3D	
Privacy Masking	Up to 24 areas	
Digital Zoom	16x	
Lens		
Focal Length	4.7mm~94mm (20x Optical zoom)	4.3mm~129mm (30x Optical zoom)
Max Aperture	F1.4 ~ F2.6	F1.6 ~ F5.0
Focus Control	Auto / Manual	
Angle of View	H: 54.1° ~ 3.2°	H: 65.1° ~ 2.34°
Close Focus Distance	100mm~ 1000mm	
PTZ		
Pan/Tilt Range	Pan: 0° ~ 360° endless; Tilt: -2° ~ 90°, auto flip 180°	
Manual Control Speed	Pan: 0.1° ~300° /s; Tilt: 0.1° ~150° /s	
Preset Speed	Pan: 300° /s; Tilt: 200° /s	
Preset	80(DH-SD), 255(Pelco-P/D)	
PTZ Mode	5 Pattern, 8 Tour, Auto Pan, Auto Scan	
Speed Setup	Human-oriented focal length/ speed adaptation	
Power up Action	Auto restore to previous PTZ and lens status after power failure	
Idle Motion	Activate Preset/ Pan/ Scan/ Tour/ Pattern if there is no command in the specified period	
Protocol	DH-SD, Pelco-P/D (Auto recognition)	
Audio		
Interface	1 channel In	

DH-SD63220I/230I-HC

Auxiliary Interface	
RS485	1
Alarm	2/1 channel In/Out
General	
Power Supply	AC 24V/3A ($\pm 10\%$)
Power Consumption	9.5W, 21W (Heater on)
Working Environment	-40°C ~ 60°C / Less than 90% RH
Ingress Protection	IP66
Vandal Resistance	IK10 (Optional)
Dimensions	$\Phi 222(\text{mm}) \times 322(\text{mm})$
Weight	6.8kg

DH-SD63220I/230I-HC

Dimensions (mm)

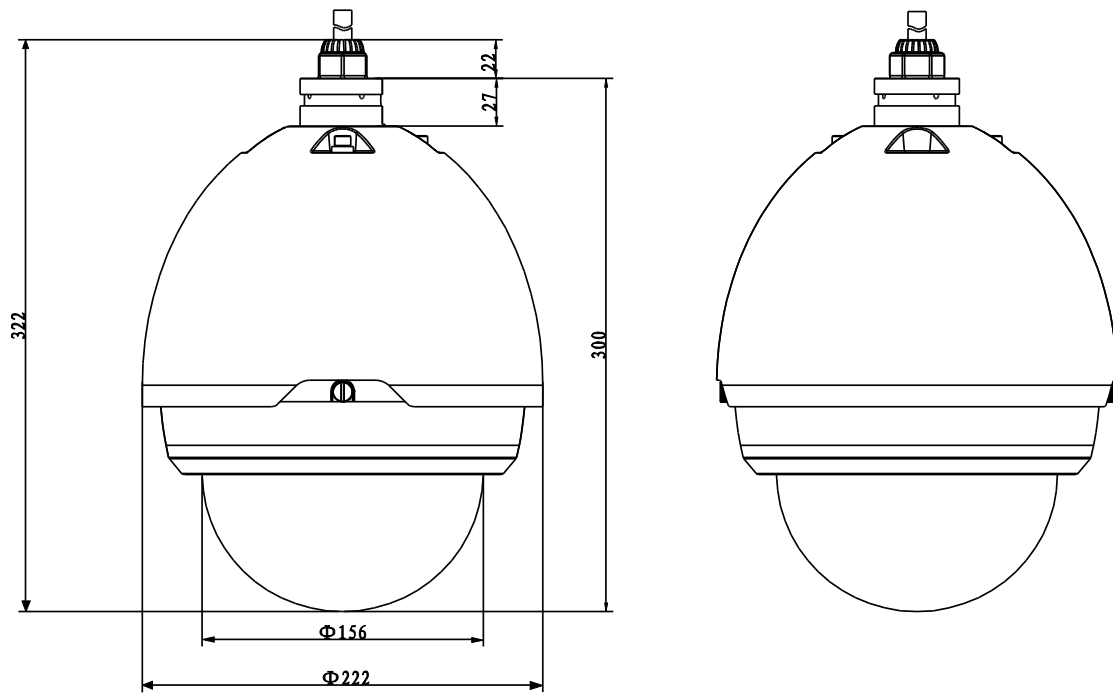







Accessories

DH-PFB303W	DH-PFA111	Power Supply

DH-SD63220I/230I-HC

Accessories (Optional)

		
DH-PFB300C	DH-PFA112	DH-PFA113

		
DH-PFA120	DH-PFA150	DH-PFA151

Dahua Technology Co., Ltd.

1187 BinAn Road, Binjiang District, Hangzhou, China

Tel: +86-571-87688883

Fax: +86-571-87688815

Email: overseas@dahuatech.com

www.dahuatech.com

*Design and specifications are subject to change without notice.

© 2013 Dahua Technology Co., Ltd.