

HG1214FCS-3

12.0mm F1.4
for 1/2" format cameras
CS-Mount

with Focus, w/o Amplifier

Model No.	HG1214FCS-3		Effective	Front	φ 13.0 mm
Focal Length	12.0mm		Lens Aperture	Rear	φ 8.8 mm
Max. Aperture Ratio	1 : 1.4		Back Focal Length	8.6 mm	
Max. Image Format	6.4 x 4.8mm (φ 8mm)		Flange Back Length	12.5 mm	
Operation Range	Iris	F1.4 ~ 360	Mount	CS-Mount	
	Focus	0.3m ~ Inf.	Filter Size	M30.0 P=0.5	
Control	Iris	Auto Iris(by galvanometer)	Dimensions	φ 32.0 × 39.8 × 33.0 mm	
	Focus	Manual	Weight	35g	
Object Dimension at M.O.D.	16.3 x 12.0cm				
Angle of View	D	38.3°			
	H	30.4°			
	V	22.7°			
Coil	Drive	190 Ω			
	Control	855 Ω			
Operating Temperature	-20 ~ +50° C				

1/2

CS

AG

M.O.D. : Minimum Object Distance

Dimensions

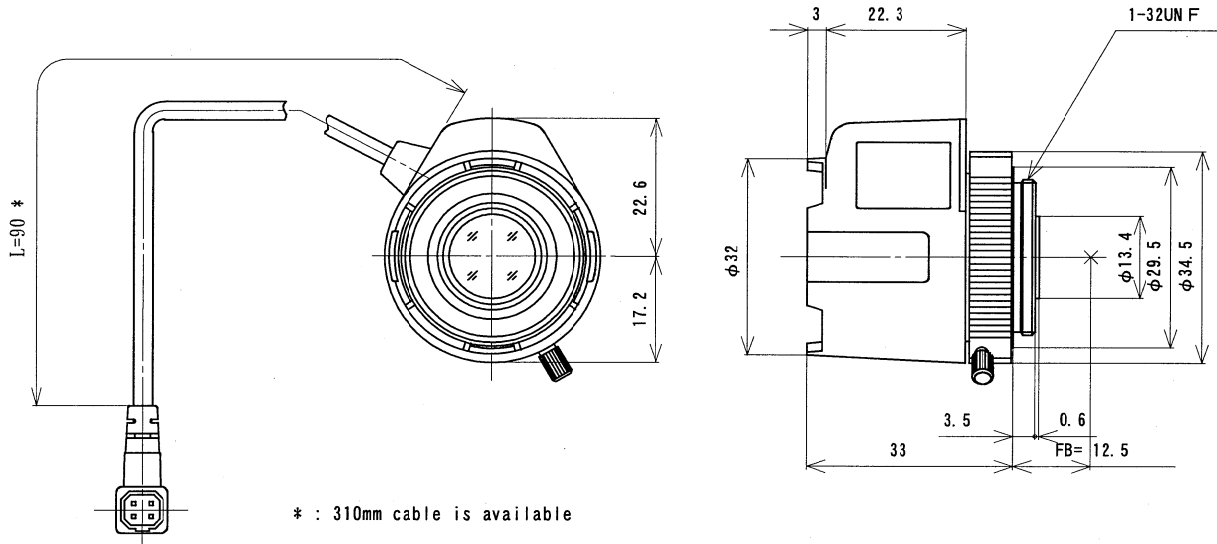

Wiring Diagram

