



RS232 KIT



Installation Guide



Building Block Video Ltd.,
17 Apex Park
Diplocks Industrial Estate,
Hailsham, East Sussex, BN27 3JU UK.
Tel: +44 (0)1323 842727
Fax: +44 (0)1323 842728
Support: +44(0)1323 444600

TABLE OF CONTENTS

1. Pre-installation Checks and Safety Procedures	3
Unpacking	3
Important safety precautions	3
2. Introduction	5
Technical Specification	5
Connection Information	6
3. System schematic diagrams	7
<i>Fig. 2 Integration between the Interflex and the CTI16 card.</i>	7
<i>Fig. 3 List of cameras and Receivers that can be controlled by a CTI.</i>	8
<i>Fig.4 RS232 Kit Being used to connect the Tx1500 to the Laptop when using the Upload Download GUI.</i>	9
<i>Fig.5 RS232 Kit Being used to connect the Tx1500 to the Laptop when Reprogramming the Tx1500 Matrix.</i>	10
<i>Fig.6 RS232 Kit Being used to connect an Rx45X & Rx55X to a Laptop when reprogramming the Receiver.</i>	11

PRE-INSTALLATION CHECKS AND SAFETY PROCEDURES

UNPACKING

Check Packaging - Upon taking delivery of the unit, inspect the packaging for signs of damage. If damage has occurred, advise the carriers and/or the suppliers immediately.

Check Contents - Upon taking delivery of the unit, unpack the receiver carefully and check that all the items are present and correct. If any items are missing or damaged, contact your equipment dealer.

Retain Packaging - The shipping carton is the safest container in which to transport the unit. Retain undamaged packaging for possible future use.

IMPORTANT SAFETY PRECAUTIONS

Read Instructions - All relevant safety, installation and operating instructions should be read before attempting to install, connect or operate the unit.

Retain Instructions - All safety, installation and operating instructions should be retained for future reference.

Heed Warnings - All warnings on the unit and in any relevant safety, installation or operating instructions should be adhered to.

Cleaning - Unplug the unit from the power outlet before cleaning. Do not use liquid cleaners or aerosol cleaners. Use a damp cloth for cleaning.

Attachments - Do not use attachments not recommended by the product manufacturer as they may cause hazards.

Water and Moisture - Do not expose this unit to water or dampness; for example, in an unprotected outdoor installation, or in any area classified as a wet location.

Power Sources - This unit should be operated only from the type of power source indicated on the manufacturer's label. If you are not sure of the type of power supply you intend to use, consult your equipment dealer or local power company. For units intended to operate from battery power or other sources, refer to operating instructions.

Overloading - Do not overload outlets and extension cords, as this can result in fire or electric shock.

Object and Liquid Entry - Never push objects of any kind into the unit, as they may touch dangerous voltage points or short out parts that could result in fire or electric shock. Never spill liquid of any kind on or inside the unit.

Servicing - Servicing of the unit should only be undertaken by qualified service personnel, as opening or removing covers may expose you to dangerous voltages or other hazards.

Damage Requiring Service - Servicing by qualified personnel should be carried out under the following conditions:

- (a) When the power-supply cord or plug is damaged;
- (b) If liquid has been spilled, or objects have fallen into, the unit;
- (c) If the internal electronics of the unit have been exposed to rain or water;
- (d) If the unit does not operate normally by following the operating instructions. Adjust only those controls that are covered by the operating instructions, as improper adjustment of other controls may result in damage and will often require extensive work by a qualified technician to restore the unit to normal operation;
- (e) If the unit has been dropped or the enclosure is damaged;
- (f) If the unit exhibits a distinct change in performance. This indicates a need for service.

Replacement Parts - If replacement parts are required, ensure that only replacement parts recommended by the product manufacturer are used.

Safety Check - Upon completion of any service or repairs to the unit, safety checks should be performed to ensure that the unit is in proper operating condition.

Pre-installation Checks - It is recommended that the unit be bench-tested prior to installation on the site.

Adhere to Safety Standards - All normal safety precautions as laid down by British Standards and the Health and Safety at Work Act should be observed.

WARNING

TO PREVENT DANGER OF FIRE OR SHOCK, DO NOT EXPOSE THE INTERNAL COMPONENTS OF THIS EQUIPMENT TO RAIN OR MOISTURE.

The “lightning flash with arrowhead” symbol inside an equilateral triangle is used to warn the user of this equipment that there are sufficiently high voltages within the enclosure to constitute a risk of electric shock.

The “exclamation point” symbol inside an equilateral triangle is used to alert the user of this equipment to important operating and maintenance (servicing) instructions in the literature accompanying the appliance.

Technical Specification

Power Requirements	9Vdc 500mA
Input	RS232
Outputs	1x Full Duplex RS422
Facilities	2 front panel diagnostic LEDs

Items included in this kit

- 1 x TxLD
- 1 x 9VDC 500mA PLUG TOP PSU
- 1 x SA-PL61-1 RS232 Null Modem cable (female 9 pin D-Type to female 9 pin D-Type cable)

General introduction

This unit turns RS232 to RS422 & RS422 to RS232 full duplex. It can be used to interface a PC based DVR with the

CTI 8 or 16.

The RS232 Kit is also used for programming a number of BBV systems Tx1500, Starcard Converter, BBUS Interface, Tx.MK2.TPO, CTI-8 & CTI-16, and Rx45X & Rx55X.

Because it does not Modify the data it is also can be used when Debugging RS422 & RS485 data systems.

In This manual there are a few examples how the RS232 can be utilised. There are a number of drawings on the BBV Support website www.support.bbvctv.com showing the uses of the RS232 kit.

Connection Information

RS422 Full Duplex connections

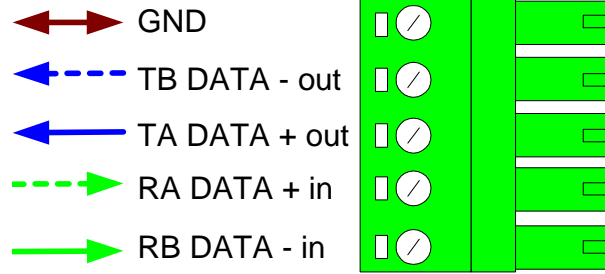

RS232 Full Duplex connections

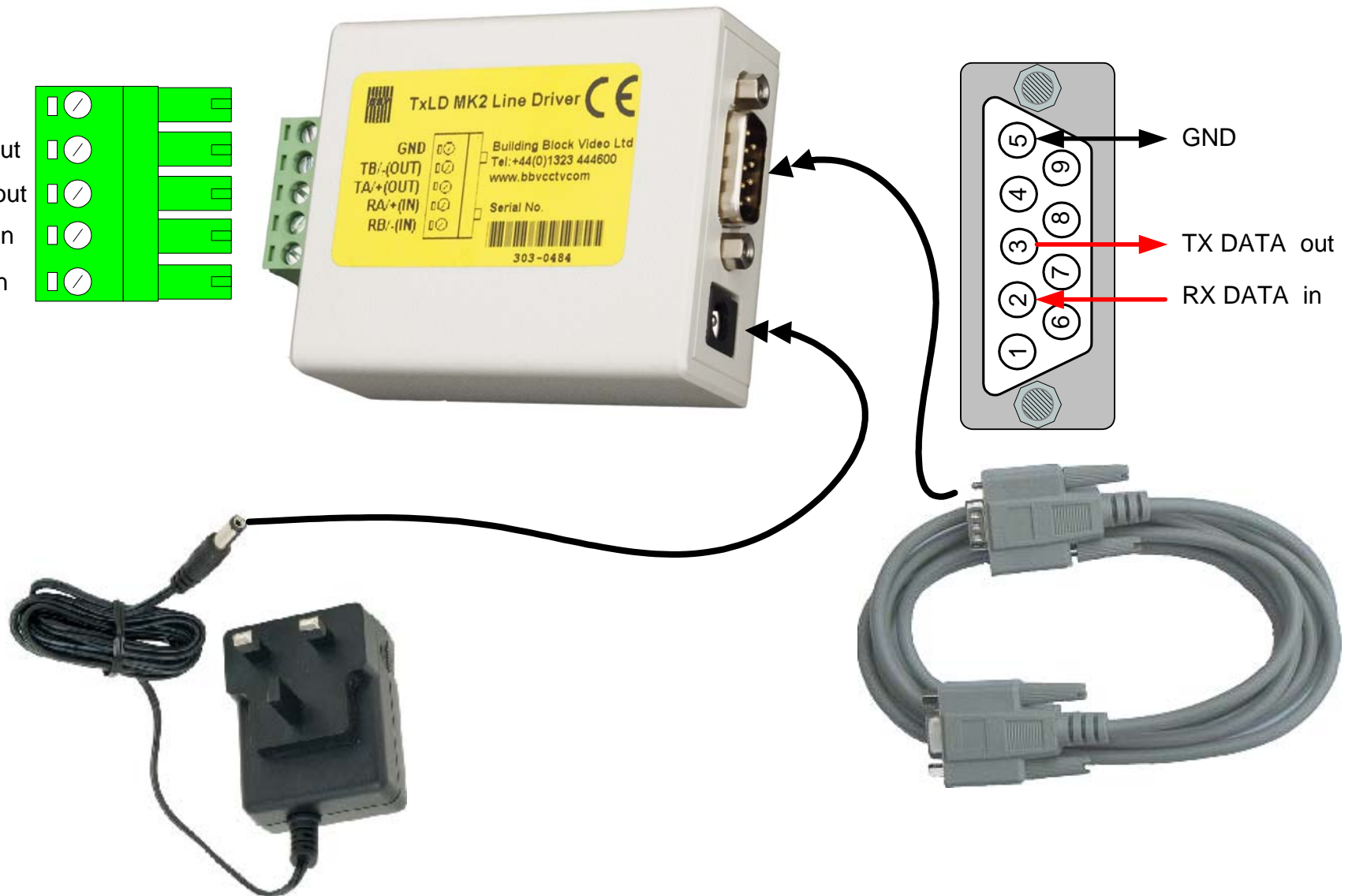

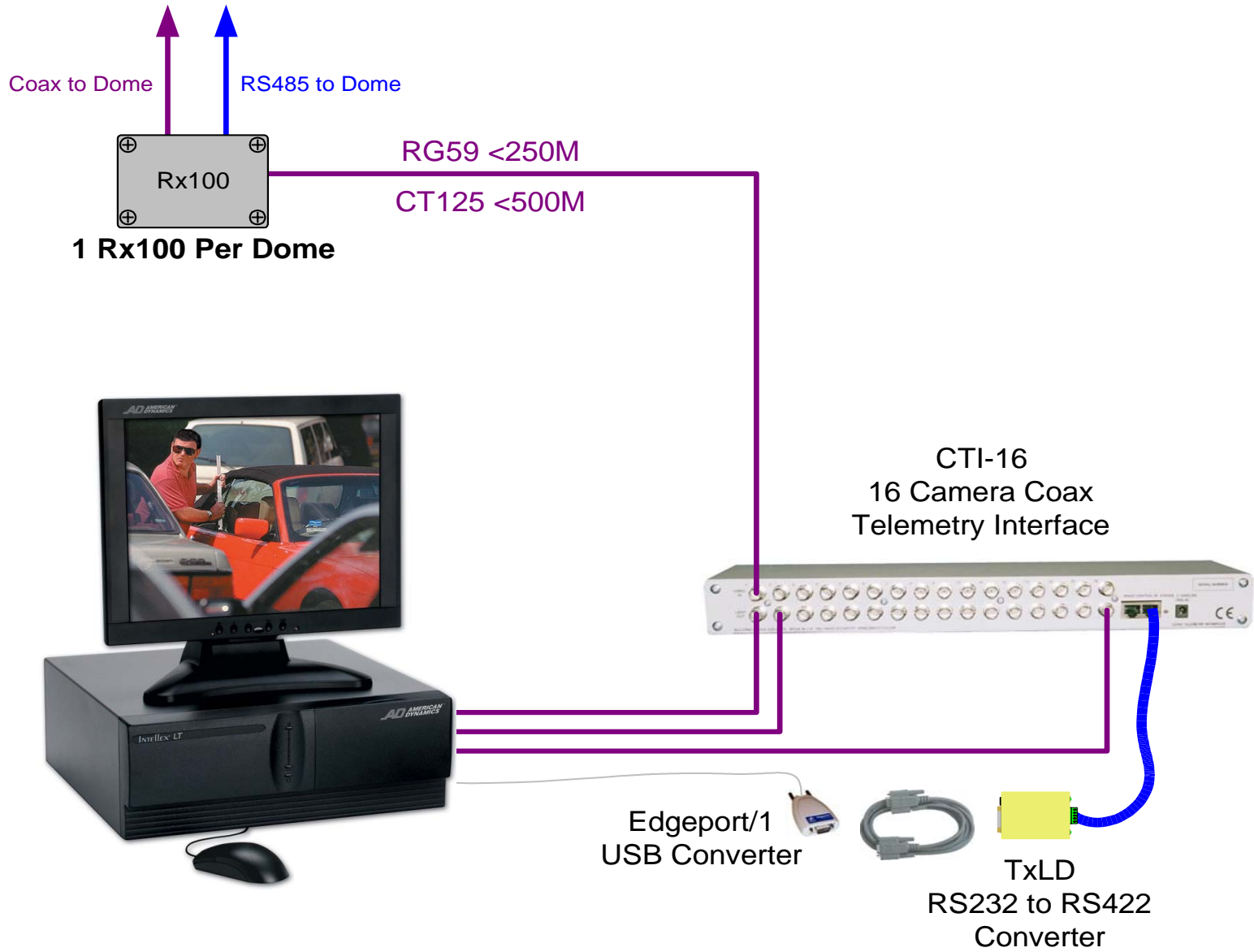

Fig. 2 Integration between the Interflex and the CTI-16 card.



Please note this is a small selection of the domes that can be controlled by the BBV Rx100 . For a full list of dome please refer to the BBV website www.bbvctv.com. It is important that the Rx100 must be close to the dome within 5 meter is recommend. The CTI Card can all so control the full range of BBV Receivers

RX200

AC output, Wash, Wipe, Lights for static cameras

RX300

AC output, Pan/Tilt/Zoom/Focus + choice of Wash, Wipe, Lights or Autopan, Random Pan.

RX400P

AC output, Pan/Tilt/Zoom/Focus/Iris, Wash, Wipe, Lights, Autopan, 16 presets, Preset patrol

RX45X

Advanced Telemetry Receiver – fixed speed AC P/T head. 32 presets, 8 alarm inputs, OSD programming menu. Remote gain control. Selectable between 230Vac or 110Vac supply. 12Vdc 500mA camera supply output. Links selectable mains or 24Vac output. Wash, Wipe, Lights and Autopan outputs.

RX55X

As RX45X to drive 24Vdc high/variable speed P/T head. Wash, Wipe and Lights outputs.

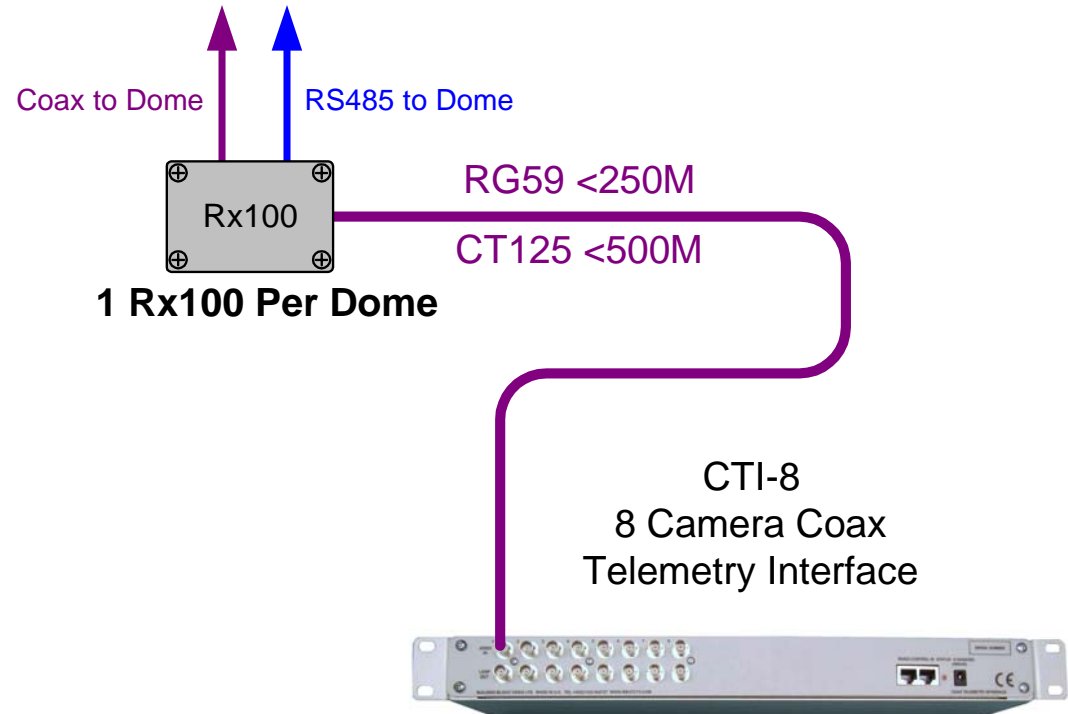
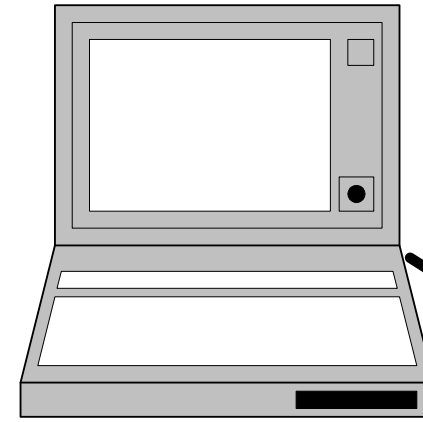

Fig. 3 List of cameras and Receivers that can be controlled by a CTI (Coax Telemetry Interface)

USE THE TELEMTRY PORT TO PROGRAM MATRIX



The Tx1500 can have all its configuration uploaded & Downloaded from a PC running a BBV Program. With this application you can also assigned camera titles & Alarm configuration.



Laptop computer

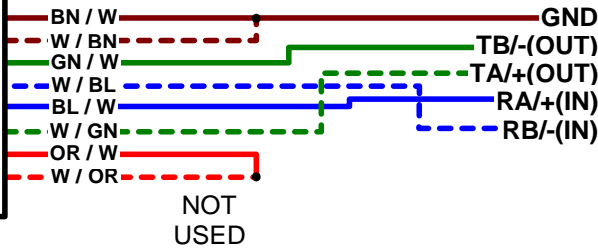
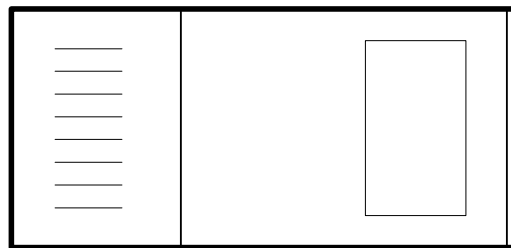
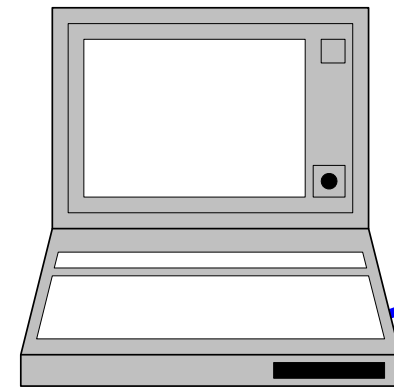
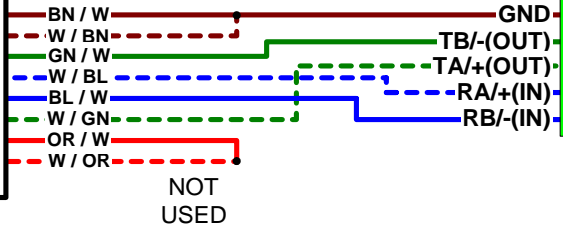
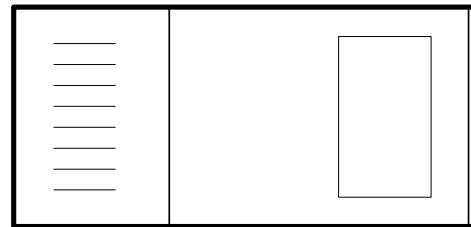

Fig.4 RS232 Kit Being used to connect the Tx1500 to the Laptop when using the [Upload Download GUI](#).

USE BBUS PORT TO PROGRAM MATRIX



Programming LINK found at the rear of Matrix you will need to remove rear panel



Laptop computer

Fig.5 RS232 Kit Being used to connect the Tx1500 to the Laptop when reprogramming the matrix.

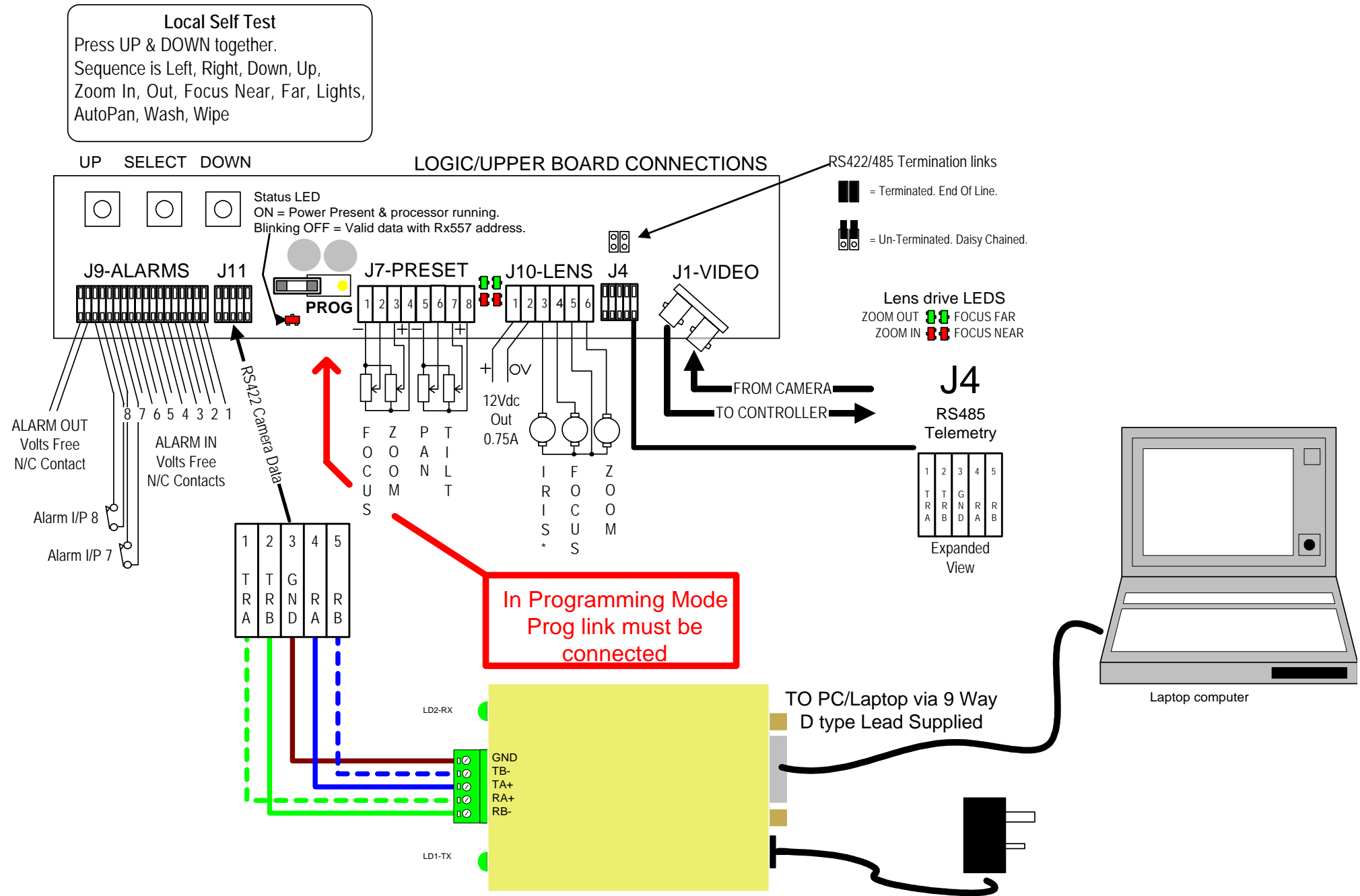

Fig.6 RS232 Kit Being used to connect an Rx45X & Rx55X to the Laptop when reprogramming the Receiver.

Other BBV products.

Product	Description
TX300	Single camera desktop telemetry transmitter with BBV up-the-coax & 20mA telemetry, Pan/Tilt/Lens & Lights
TX400	As TX300 inc Wash, Wipe, Autopan, 8 presets, preset patrol.
TX400DC/RS485	As TX400 including joystick for proportional Pan/Tilt control with RS485 Output.
TX1000 MK2	8 or 16 camera, 2 monitor telemetry transmitter. Up to 2 keyboards. BBV up-the-coax and RS422 standard with options for alarm inputs and 20mA telemetry.
TX1500	Mid size matrix 16 – 96 camera, 8 monitor. Up to 4 control positions (keyboard & remote control) options for alarms, remote control, BBV up-the-coax and RS485 telemetry.
FBM range	Large size matrix. Configurable up to 4096 cameras and 64 monitor outputs. Up to 16 control positions (keyboard & remote control) options for alarms, remote control RS485/RS422 telemetry with various options. Please call to discuss requirements.
RX100	Dome Interface with options to drive a large library of dome cameras. BBV up-the-coax and 20mA telemetry.
RX100/BAX	Dome Interface with options to drive a large library of dome cameras. BAXALL up-the-coax telemetry.
RX200	AC receiver for Pan only heads or static cameras, Wash/Wipe/Lights. BBV up-the-coax and 20mA telemetry.
RX300	AC receiver for Pan/Tilt/Zoom/Focus/Iris Override and 1 Auxiliary output. BBV up-the-coax and 20mA telemetry.
RX400P	AC full function receiver. PTZFI 4 Auxiliary outputs, 16 presets. BBV up-the-coax and 20mA telemetry.
RX45X (AC) RX55X (DC) Multi RS485 protocol and BBV up-the-coax telemetry receivers	Multiple RS485/422 and BBV up-the-coax controllable AC and DC receivers. These receivers are controlled from an expanding range of serial protocols as listed below. 110/230Vac supply. PTZFI, 64 presets, preset patrol, 8 local alarm inputs, 12V 500mA supply output. OSD for remote diagnostics. 3 Aux. outputs RX55X or 4 Aux. outputs RX45X. Optional Privacy board. BBV RS485, COAX & 20mA, BAXALL COAX, DENNARD RS485, MOLYNX, PELCO P/D RS485, VCL/HONEYWELL RS485, PHILIPS/BOSCH RS485 (OPTIONAL BI-PHASE INPUT), SENSORMATIC/AD RS422 VICON RS422 & CIRBUS AUDIO MONITORING
RX450/550	PANASONIC RS485 Protocol only version of RX45X/55X.
CTI16 CTI8	Multi-protocol serial converter that gives either 8 or 16 channels of up-the-coax control (BBV Coax protocol). BBV RS422, Dennard RS485, Pelco P, Pelco D, Philips/Bosch RS485/232, VCL RS485, Sensormatic RS422, Molyntx, Vicon
STARCARD STARCARD/CONVERTER	8 * RS485 output, 2 wire simplex RS422, 4 wire full-duplex RS422, 2 wire half-duplex RS485. Optional STARCARD/CONVERTER offering protocol conversion to drive an increasing range of 3 rd party protocols.
ACCESSORIES	TxLD (bidirectional RS422-RS232 converter) 98005 (bidirectional 20mA-RS232 converter) AD RS422 (American Dynamics) protocol converters