

IR LED Illuminator

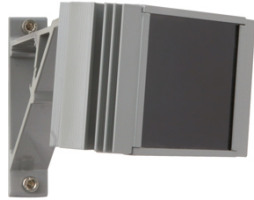

FEATURES

- Compact chassis
- MTBF > 100,000 hours

SPECIFICATIONS

Optical Wavelength	880 nm
Max. IR Distance	30 m
Beam Angle	90°
Protection Rating	IP66
MTBF at 25° C	> 100,000 hours
Supply Voltage	12 VDC / 220 VAC
Including	Bracket & PSU included
Power Consumption	15 W
Weight	1 kg
Dimensions w*h*d	219 x 134 x 134 mm

IR LED Illuminator

DIMENSIONS

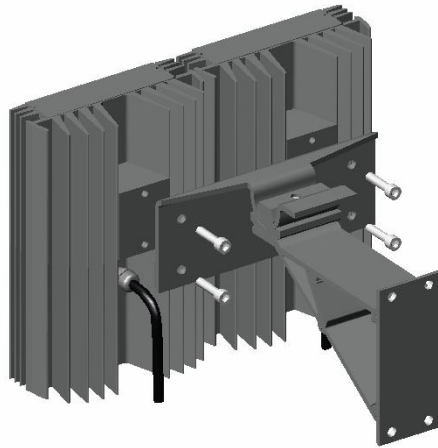

Angles of view

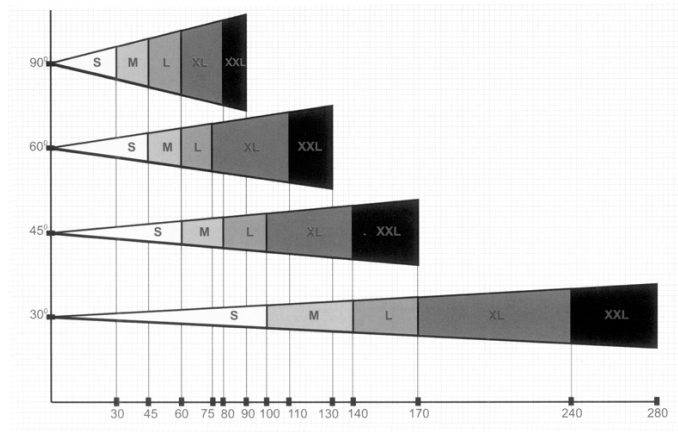

IR LED Illuminator

ACCESSORIES



AST ST3
IR LED Illuminator wall bracket

